

SAI SCHOOL OF ENGINEERING

LECTURE NOTES
ON
THEORY OF MACHINE



SAI SCHOOL OF ENGINEERING
A.KATAPALI, BURLA, SAMBALPUR

SYLLABUS

1.0 Simple mechanism 1.1 Link ,kinematic chain, mechanism, machine 1.2 Inversion, four bar link mechanism and its inversion 1.3 Lower pair and higher pair 1.4 Cam and followers

2.0 Friction 2.1 Friction between nut and screw for square thread, screw jack 2.2 Bearing and its classification, Description of roller, needle roller& ball bearings. 2.3 Torque transmission in flat pivot& conical pivot bearings. 2.4 Flat collar bearing of single and multiple types. 2.5 Torque transmission for single and multiple clutches 2.6 Working of simple frictional brakes.2.7 Working of Absorption type of dynamometer

3.0 Power Transmission 3.1 Concept of power transmission 3.2 Type of drives, belt, gear and chain drive. 3.3 Computation of velocity ratio, length of belts (open and cross)with and without slip. 3.4 Ratio of belt tensions, centrifugal tension and initial tension. 3.5 Power transmitted by the belt. 3.6 Determine belt thickness and width for given permissible stress for open and crossed belt considering centrifugal tension. 3.7 V-belts and V-belts pulleys. 3.8 Concept of crowning of pulleys. 3.9 Gear drives and its terminology. 3.10 Gear trains, working principle of simple, compound, reverted and epicyclic gear trains.

4.0 Governors and Flywheel 4.1 Function of governor 4.2 Classification of governor 4.3 Working of Watt, Porter, Proel and Hartnell governors. 4.4 Conceptual explanation of sensitivity, stability and isochronisms. 4.5 Function of flywheel. 4.6 Comparison between flywheel &governor. 4.7 Fluctuation of energy and coefficient of fluctuation of speed.

5.0 Balancing of Machine 5.1 Concept of static and dynamic balancing. 5.2 Static balancing of rotating parts. 5.3 Principles of balancing of reciprocating parts. 5.4 Causes and effect of unbalance. 5.5 Difference between static and dynamic balancing

Vibration of machine parts 6.1 Introduction to Vibration and related terms (Amplitude, time period and frequency, cycle) 6.2 Classification of vibration. 6.3 Basic concept of natural, forced & damped vibration 6.4 Torsional and Longitudinal vibration. 6.5 Causes & remedies of vibration

Module-1

What is Kinematics? Kinematics is the study of motion (position, velocity, acceleration). A major goal of understanding kinematics is to develop the ability to design a system that will satisfy specified motion requirements. This will be the emphasis of this class.

What is Kinetics? Kinetics is the study of effect of forces on moving bodies. Good kinematic design should produce good kinetics.

Definitions Link:

A link is defined as a member or a combination of members of a mechanism connecting other members and having relative motion between them. The link may consist of one or more resistant bodies. A link may be called as kinematic link or element. Eg: Reciprocating steam engine.

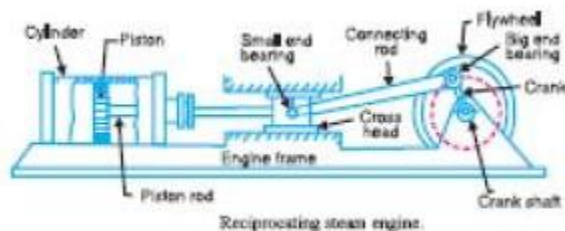

Classification of link is binary, ternary and quaternary.

Joint: A connection between two links that allows motion between the links. The motion allowed may be rotational (revolute joint), translational (sliding or prismatic joint), or a combination of the two (roll-slide joint).

Kinematic pair: Kinematic pair is a joint of two links having relative motion between them. The types of kinematic pair are classified according to

- Nature of contact (lower pair, Higher pair)
- Nature of mechanical contact (Closed pair, unclosed pair)
- Nature of relative motion (Sliding pair, turning pair, rolling pair, screw pair, spherical pair)

classification of kinematics pairs

According to the type of relative motion between the elements

a) Sliding pair:- When the elements of a pair are connected in such a way that one can only slide relative to the other, the pair is known as a sliding pair.

- The piston and cylinder, cross-head
- Guides of a reciprocating steam engine
- Ram and its guides in shaper
- Tail stock on the lathe bed

(b) Turning pair:- When the elements of a pair are connected in such a way that one can only turn or revolve relative to another link, the pair is known as turning pair.

- A shaft with collars at both ends fitted into a circular hole
- The crankshaft in a journal bearing in an engine
- Lathe spindle supported in head stock
- Cycle wheels turning over their axles

are the examples of a turning pair

(c) **Rolling pair:-** When the elements of a pair are connected in such a way that one link rolls over another fixed link, the pair is known as rolling pair.

- Ball and roller bearings

(d) **Screw pair:-** When the elements of a pair are connected in such a way that one element turns about the other by screw threads, the pair is known as screw pair.

- The lead screw of a lathe with nut
- Bolt with a nut

(e) **Spherical pair:-** When the elements of a pair are connected in such a way that one element turns or swivels about the other fixed element, the pair formed is called a spherical pair.

- The ball and socket joint
- Attachment of a car mirror
- Pen stand

According to the type of contact between the elements

(a) **Lower pair:-** When the elements of a pair having a surface contact between them when relative motion takes place and the surface of one element slides over the surface of the other, the pair formed is known as lower pair.

- sliding pairs
- turning pairs
- screw pairs

(b) **Higher pair:-** When the elements of a pair having a line or point contact between them when relative motion takes place and the motion between the two elements is partly turning and partly sliding, then the pair is known as higher pair.

- Pair of friction discs
- toothed gearing
- Belt and rope drives

According to nature of mechanical constraint

(a) **Closed pair:-** When the elements of a pair are held together mechanically in such a way that only required relative motion occurs, it is then known as closed pair.

- The lower pairs are closed pair.

(b) **Un closed pair/Open Pair:-** When the elements of a pair are in contact either due to force of gravity or spring action, the pair is called as a Un-closed pair or Open Pair.

- The cam and follower and gravity

Kinematic chain: When the kinematic pairs are coupled in such a way that the last link is joined to the first link to transmit definite motion it is called a kinematic chain. Eg: The crank shaft of an engine forms a kinematic pair with the bearings which are fixed in a pair, the connecting rod with the crank forms a second kinematic pair, the piston with the connecting rod forms a third pair and the piston with the cylinder forms the fourth pair.

The total combination of these links is a kinematic chain. Eg: Lawn mover

Here, we had to check whether the given link is a kinematic chain We can use two formulas

$$1. l = 2p - 4$$

$$2. j = (3/2)l - 2$$

Mechanism If motion of any of the movable links results in definite motions of the others the linkage is known as mechanism

Machine When a mechanism is required to transmit power or to do some particular type of work it then becomes a machine.

Degrees of Freedom It is defined as the number of input parameters which must be independently controlled in order to bring the mechanism in to useful engineering purposes. It is also defined as the number of independent relative motions, both translational and rotational, a pair can have. Degrees of freedom = 6 – no. of restraints. To find the number of degrees of freedom for a plane mechanism we have **Grubler's**

$$\text{equation } F = 3(n - 1) - 2j_1 - j_2$$

F = Mobility or number of degrees of freedom

n = Number of links including frame.

j₁ = Joints with single (one) degree of freedom.

j₂ = Joints with two degrees of freedom.

F > 0, results in a mechanism with 'F' degrees of freedom.

F = 0, results in a statically determinate structure.

F < 0, results in a statically indeterminate structure

Grashoff's law:

Grashoff 4-bar linkage: A linkage that contains one or more links capable of undergoing a full rotation. A linkage is Grashoff if: $S + L < P + Q$ (Where: S = shortest link length, L = longest, P, Q = intermediate length links). Both joints of the shortest link are capable of 360 degrees of rotation in a Grashoff linkages. This gives us 4 possible linkages:

crank-rocker (input rotates 360)

rocker-crank-rocker (coupler rotates 360)

rocker-crank (follower)

double crank (all links rotate 360).

Inversion of Mechanism

we can obtain as many mechanisms as the number of links in a kinematic chain by fixing, in turn, different links in a kinematic chain. This method of obtaining different mechanisms by fixing different links in a kinematic chain, is known as ***inversion of the mechanism***

Types of Kinematic Chains

The most important kinematic chains are those which consist of four lower pairs, each pair being a sliding pair or a turning pair. The following three types of kinematic chains with four lower pairs are important from the subject point of view :

1. Four bar chain or quadric cyclic chain,
2. Single slider crank chain, and
3. Double slider crank chain.

Inversions of Four Bar Chain

Though there are many inversions of the four bar chain, yet the following are important from the subject point of view :

1. Beam engine (crank and lever mechanism).

A part of the mechanism of a beam engine (also known as crank and lever mechanism) which consists of four links, is shown in Fig. In this mechanism, when the crank rotates about the fixed centre *A*, the lever oscillates about a fixed centre *D*. The end *E* of the lever *CDE* is connected to a piston rod which reciprocates due to the rotation of the crank. In other words, the purpose of this mechanism is to convert rotary motion into reciprocating motion.

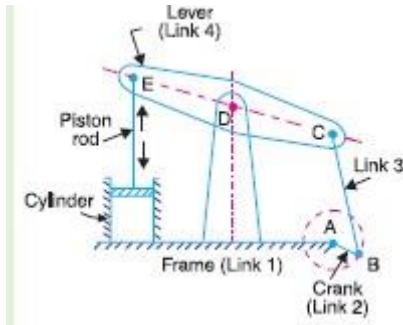

2. Coupling rod of a locomotive (Double crank mechanism). The mechanism of a coupling rod of a locomotive (also known as double crank mechanism) which consists of four links, is shown in Fig.

In this mechanism, the links *AD* and *BC* (having equal length) act as cranks and are connected to the respective wheels. The link *CD* acts as a coupling rod and the link *AB* is fixed in order to maintain a constant centre to centre distance between them. This mechanism is meant for transmitting rotary motion from one wheel to the other wheel

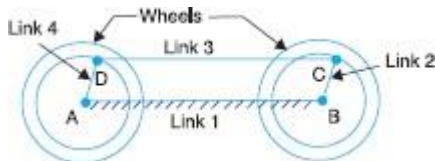

3. Watt’s straight line mechanism or Double lever mechanism: In this mechanism, the links *AB* & *DE* act as levers at the ends *A* & *E* of these levers are fixed. The *AB* & *DE* are parallel in the mean position of the mechanism and coupling rod *BD* is perpendicular to the levers *AB* & *DE*. On any small displacement of the mechanism the tracing point ‘*C*’ traces the shape of number ‘8’, a portion of which will be approximately straight. Hence this is also an example for the approximate straight line mechanism. This mechanism is shown below

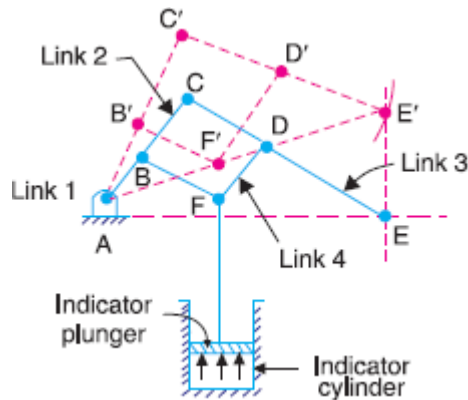

Inversions of Slider crank Chain: It is a four bar chain having one sliding pair and three turning pairs. It is shown in the figure below the purpose of this mechanism is to convert rotary motion to reciprocating motion and vice versa.

There are four inversions in a single slider chain mechanism.

They are: 1) Reciprocating engine mechanism (1st inversion)

2) Oscillating cylinder engine mechanism (2nd inversion)

3) Crank and slotted lever mechanism (2nd inversion)

4) Whitworth quick return motion mechanism (3rd inversion)

5) Rotary engine mechanism (3rd inversion)

6) Bull engine mechanism (4th inversion)

7) Hand Pump (4th inversion)

Reciprocating engine mechanism: In the first inversion, the link 1 i.e., the cylinder and the frame is kept fixed. The fig below shows a reciprocating engine

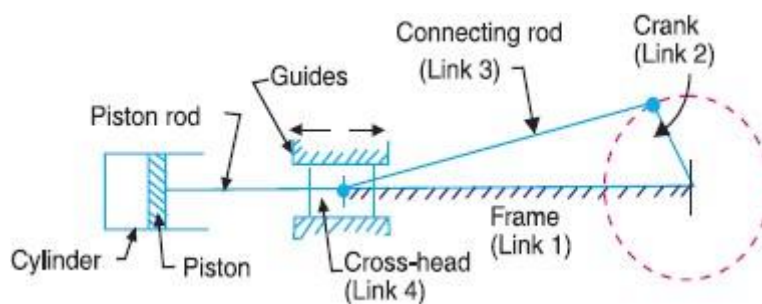

A slotted link 1 is fixed. When the crank 2 rotates about O, the sliding piston 4 reciprocates in the slotted link 1. This mechanism is used in steam engine, pumps, compressors, I.C. engines, etc.

Crank and slotted lever mechanism: It is an application of second inversion. The crank and slotted lever mechanism is shown in figure below

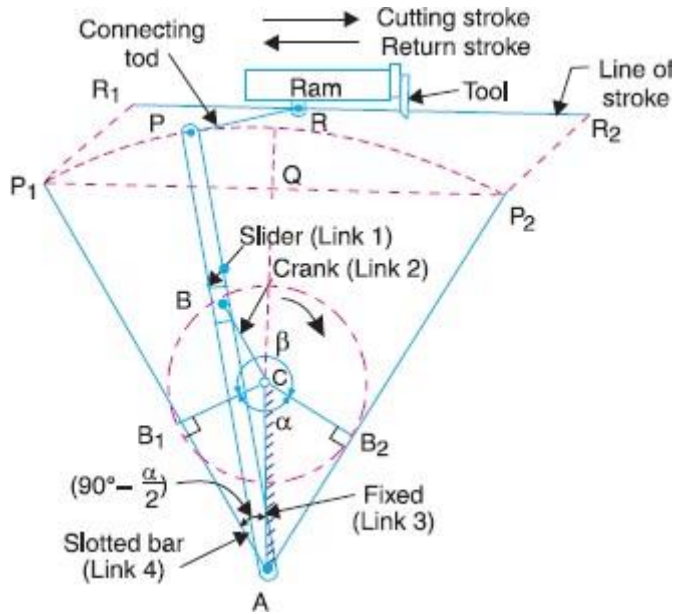

In this mechanism link 3 is fixed. The slider (link 1) reciprocates in oscillating slotted lever (link 4) and crank (link 2) rotates. Link 5 connects link 4 to the ram (link 6). The ram with the cutting tool reciprocates perpendicular to the fixed link 3. The ram with the tool reverses its direction of motion when link 2 is perpendicular to link 4. Thus the cutting stroke is executed during the rotation of the crank through angle α and the return stroke is executed when the crank rotates through angle β or $360 - \alpha$. Therefore, when the crank rotates uniformly, we get,

$$\frac{\text{Time of cutting stroke}}{\text{Time of return stroke}} = \frac{\beta}{\alpha} = \frac{\beta}{360^\circ - \beta} \quad \text{or} \quad \frac{360^\circ - \alpha}{\alpha}$$

Whitworth quick return motion mechanism

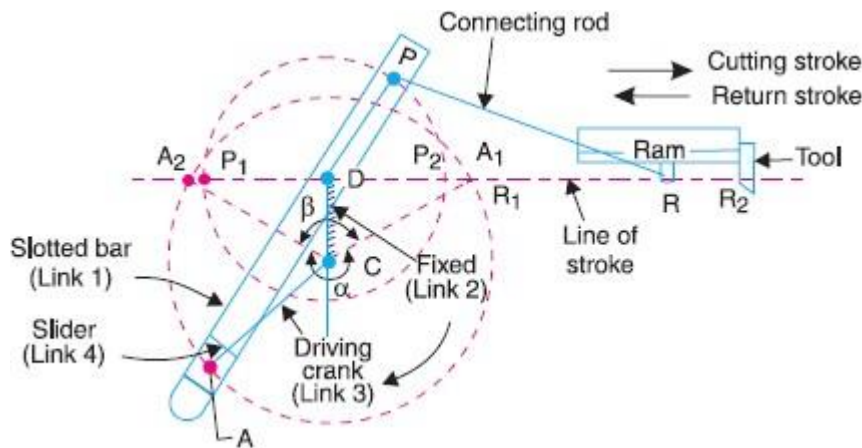

Third inversion is obtained by fixing the crank i.e. link 2. Whitworth quick return mechanism is an application of third inversion. This mechanism is shown in the figure below. The crank OC is fixed and OQ rotates about O. The slider slides in the slotted link and generates a circle of radius CP. Link 5 connects the extension OQ provided on the

opposite side of the link 1 to the ram (link 6). The rotary motion of P is taken to the ram R which reciprocates. The quick return motion mechanism is used in shapers and slotting machines. The angle covered during cutting stroke from P1 to P2 in counter clockwise direction is α or $360 - 2\theta$. During the return stroke, the angle covered is 2θ or β .

$$\frac{\text{Time of cutting stroke}}{\text{Time of return stroke}} = \frac{\beta}{\alpha} = \frac{\beta}{360^\circ - \beta} \quad \text{or} \quad \frac{360^\circ - \alpha}{\alpha}$$

Rotary engine mechanism or Gnome Engine:

Rotary engine mechanism or gnome engine is another application of third inversion. It is a rotary cylinder V – type internal combustion engine used as an aero – engine. But now Gnome engine has been replaced by Gas turbines. The Gnome engine has generally seven cylinders in one plane. The crank OA is fixed and all the connecting rods from the pistons are connected to A. In this mechanism when the pistons reciprocate in the cylinders, the whole assembly of cylinders, pistons and connecting rods rotate about the axis O, where the entire mechanical power developed, is obtained in the form of rotation of the crank shaft. This mechanism is shown in the figure below

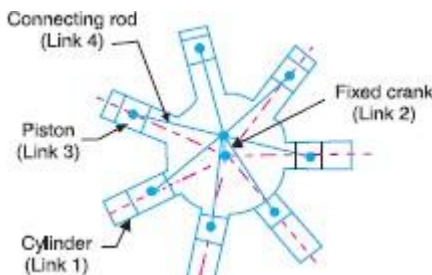

Double Slider Crank Chain: A four bar chain having two turning and two sliding pairs such that two pairs of the same kind are adjacent is known as double slider crank chain.

Inversions of Double slider Crank chain: It consists of two sliding pairs and two turning pairs. There are three important inversions of double slider crank chain.

- 1) Elliptical trammel.
- 2) Scotch yoke mechanism.
- 3) Oldham’s Coupling.

Elliptical Trammel: This is an instrument for drawing ellipses. Here the slotted link is fixed. The sliding block P and Q in vertical and horizontal slots respectively. The end R generates an ellipse with the displacement of sliders P and Q.

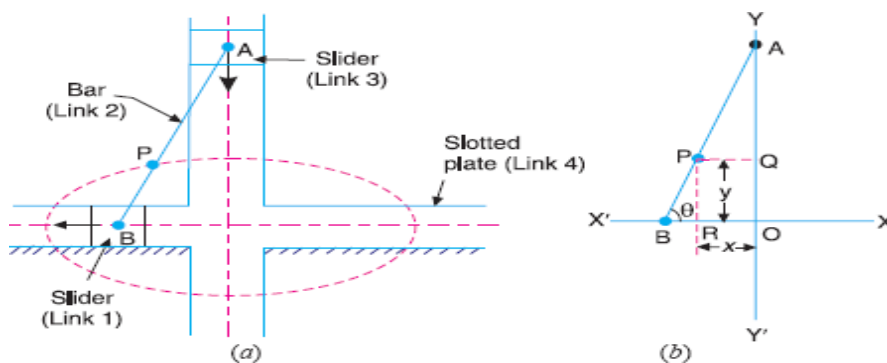

Let us take OX and OY as horizontal and vertical axes and let the link BA is inclined at an angle θ with the horizontal, as shown in Fig. 5.34 (b). Now the co-ordinates of the point P on the link BA will be

$$x = PQ = AP \cos \theta; \text{ and } y = PR = BP \sin \theta$$

or
$$\frac{x}{AP} = \cos \theta; \text{ and } \frac{y}{BP} = \sin \theta$$

Squaring and adding,

$$\frac{x^2}{(AP)^2} + \frac{y^2}{(BP)^2} = \cos^2 \theta + \sin^2 \theta = 1$$

This is the equation of an ellipse. Hence the path traced by point P is an ellipse whose semi-major axis is AP and semi-minor axis is BP .

Note : If P is the mid-point of link BA , then $AP = BP$. The above equation can be written as

$$\frac{x^2}{(AP)^2} + \frac{y^2}{(AP)^2} = 1 \quad \text{or} \quad x^2 + y^2 = (AP)^2$$

This is the equation of a circle whose radius is AP . Hence if P is the mid-point of link BA , it will trace a circle.

Scotch yoke mechanism: This mechanism is used to convert rotary motion in to reciprocating motion. The inversion is obtained by fixing either the link 1 or link 3. Link 1 is fixed. In this mechanism when the link 2 rotates about B as centre, the link 4 reciprocates. The fixed link 1 guides the frame.

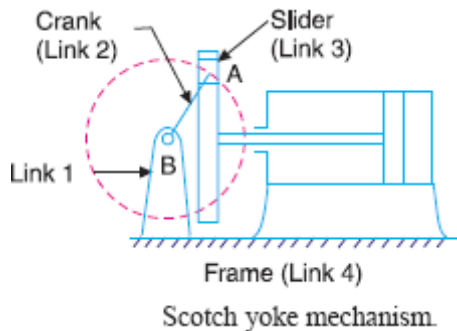

Oldham's coupling: The third inversion of obtained by fixing the link connecting the 2 blocks P & Q. If one block is turning through an angle, the frame and the other block will also turn through the same angle. It is shown in the figure below

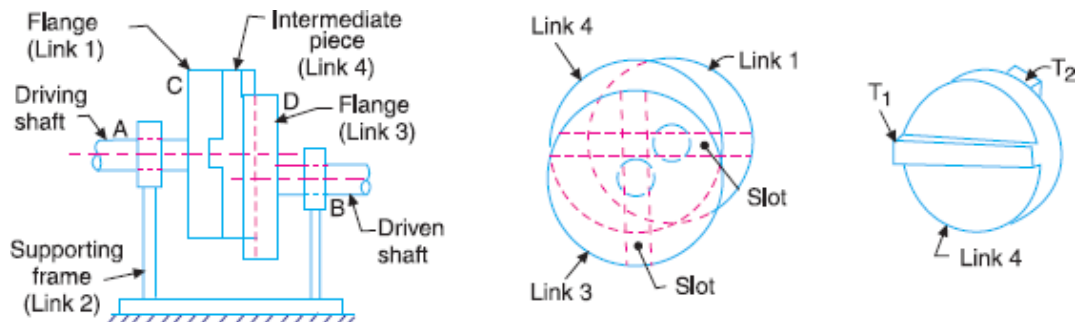

An application of the third inversion of the double slider crank mechanism is Oldham's coupling shown in the figure. This coupling is used for connecting two parallel shafts when the distance between the shafts is small. The two shafts to be connected have flanges at their ends, secured by forging. Slots are cut in the flanges. These flanges form 1

and 3. An intermediate disc having tongues at right angles and opposite sides is fitted in between the flanges. The intermediate piece forms the link 4 which slides or reciprocates in flanges 1 & 3. The link two is fixed as shown. When flange 1 turns, the intermediate disc 4 must turn through the same angle and whatever angle 4 turns, the flange 3 must turn through the same angle. Hence 1, 4 & 3 must have the same angular velocity at every instant. If the distance between the axis of the shaft is x , it will be the diameter of the circle traced by the centre of the intermediate piece. The maximum sliding speed of each tongue along its slot is given by

$$v = x\omega$$

where,

ω = angular velocity of each shaft in rad/sec

v = linear velocity in m/sec

Cam and followers

A **cam** is a rotating machine element which gives reciprocating or oscillating motion to another element known as **follower**. The cam and the follower have a line contact and constitute a higher pair. The cams are usually rotated at uniform speed by a shaft, but the follower motion is predetermined and will be according to the shape of the cam.

Classification of Followers

The followers may be classified as discussed below :

1. According to the surface in contact. The followers, according to the surface in contact, are as follows :

(a) Knife edge follower. When the contacting end of the follower has a sharp knife edge, it is called a knife edge follower, The sliding motion takes place between the contacting surfaces (*i.e.* the knife edge and the cam surface). It is seldom used in practice because the small area of contacting surface results in excessive wear. In knife edge followers, a considerable side thrust exists between the follower and the guide.

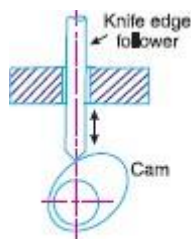

(a) Cam with knife edge follower.

(b) Roller follower. When the contacting end of the follower is a roller, it is called a roller follower, Since the rolling motion takes place between the

contacting surfaces (*i.e.* the roller and the cam), therefore the rate of wear is greatly reduced. In roller followers also the side thrust exists between the follower and the guide. The roller followers are extensively used where more space is available such as in stationary gas and oil engines and aircraft engines.

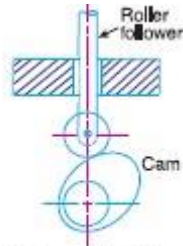

(b) Cam with roller follower.

(c) Flat faced or mushroom follower. When the contacting end of the follower is a perfectly flat face, it is called a flat-faced follower. The flat faced followers are generally used where space is limited such as in cams which operate the valves of automobile engines.

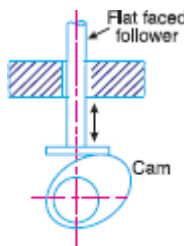

(c) Cam with flat faced follower.

(d) Spherical faced follower. When the contacting end of the follower is of spherical shape, it is called a spherical faced follower. It may be noted that when a flat-faced follower is used in automobile engines, high surface stresses are produced. In order to minimise these stresses, the flat end of the follower is machined to a spherical shape.

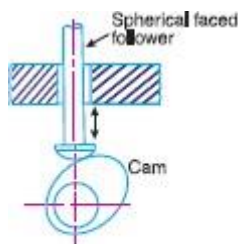

(d) Cam with spherical faced follower.

According to the motion of the follower. The followers, according to its motion, are of the following two types:

(a) Reciprocating or translating follower. When the follower reciprocates in guides as the cam rotates uniformly, it is known as reciprocating or translating follower.

(b) Oscillating or rotating follower. When the uniform rotary motion of the cam is converted into predetermined oscillatory motion of the follower, it is called oscillating or rotating follower.

3. According to the path of motion of the follower. The followers, according to its path of motion, are of the following two types:

(a) Radial follower. When the motion of the follower is along an axis passing through the centre of the cam, it is known as radial follower

(b) Off-set follower. When the motion of the follower is along an axis away from the axis of the cam centre, it is called off-set follower.

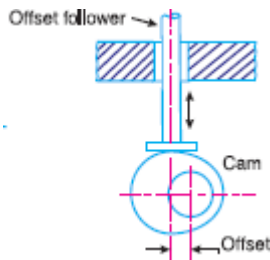

Classification of Cams

Though the cams may be classified in many ways, yet the following two types are important from the subject point of view

1. Radial or disc cam. In radial cams, the follower reciprocates or oscillates in a direction perpendicular to the cam axis. The cams as shown in Fig are all radial cams.

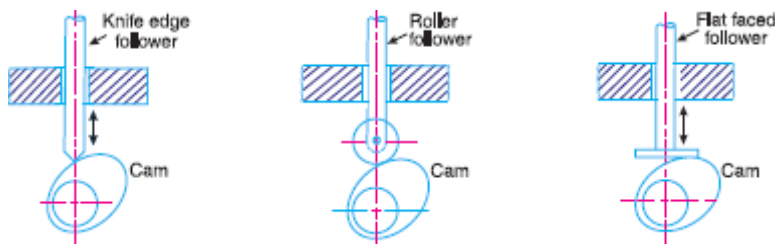

2. Cylindrical cam. In cylindrical cams, the follower reciprocates or oscillates in a direction parallel to the cam axis. The follower rides in a groove at its cylindrical surface. A cylindrical grooved cam with a reciprocating and an oscillating follower is shown in Fig

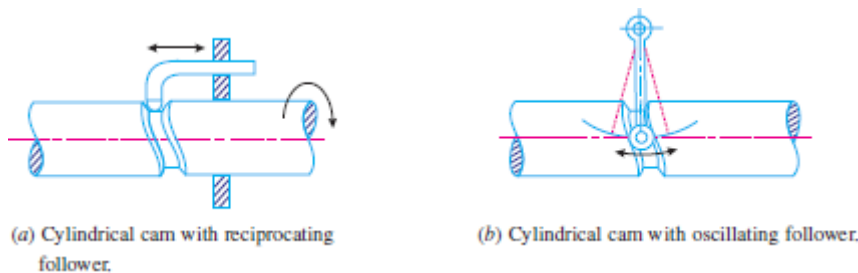

Terms Used in Radial Cams

1. Base circle. It is the smallest circle that can be drawn to the cam profile.

2. Trace point. It is a reference point on the follower and is used to generate the *pitch curve*. In case of knife edge follower, the knife edge represents the trace point and the pitch curve

corresponds to the cam profile. In a roller follower, the centre of the roller represents the trace point.

3. Pressure angle. It is the angle between the direction of the follower motion and a normal to the pitch curve. This angle is very important in designing a cam profile. If the pressure angle is too large, a reciprocating follower will jam in its bearings.

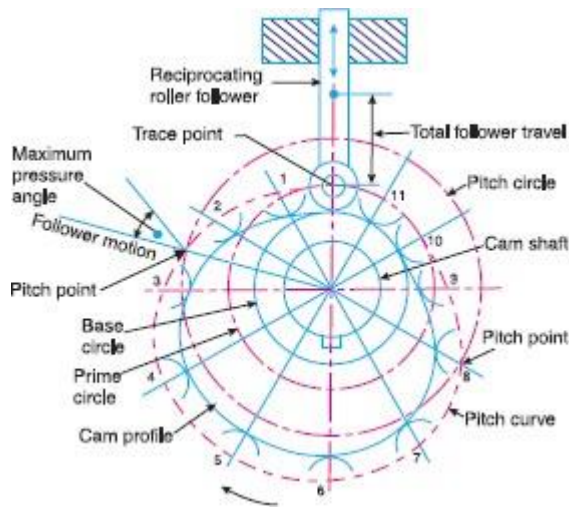

4. Pitch point. It is a point on the pitch curve having the maximum pressure angle.

5. Pitch circle. It is a circle drawn from the centre of the cam through the pitch points.

6. Pitch curve. It is the curve generated by the trace point as the follower moves relative to the cam. For a knife edge follower, the pitch curve and the cam profile are same whereas for a roller follower, they are separated by the radius of the roller.

7. Prime circle. It is the smallest circle that can be drawn from the centre of the cam and tangent to the pitch curve. For a knife edge and a flat face follower, the prime circle and the base circle are identical. For a roller follower, the prime circle is larger than the base circle by the radius of the roller.

8. Lift or stroke. It is the maximum travel of the follower from its lowest position to the Top most position.

Module 2

2.Friction 2.1 Friction between nut and screw for square thread screw jack 2.2 Bearing and its classification Description of roller needle roller& ball bearings. 2.3 Torque transmission in flat pivot& conical pivot bearings. 2.4 Flat collar bearing of single and multiple types. 2.5 Torque transmission for single and multiple clutches 2.6 Working of simple frictional brakes.2.7 Working of Absorption type of dynamometer

NORMAL FORCES

When an object rests on a surface, the surface exerts a normal force on the object, keeping it from accelerating downward.

A normal force is perpendicular to the contact surface of an object. Example – When we are standing, we do not fall through the floor because the downward force of our weight is balanced by the upward normal force exerted by the surface of the floor. The magnitudes of these forces are equal, but they are applied in opposite directions. However, if we stood on a piece of paper, the normal force of the paper would not be great enough to counteract our weight because the paper is not strong enough. The forces would be unbalanced and we would accelerate downward, falling through the paper

FRICTION

It is harder to move objects with larger inertia, but there are ways to make moving objects with larger amounts of inertia easier. One way is to reduce the amount of friction between the object and its contact surface.

Friction is a force that resists the relative motion of two objects in contact, caused by the irregularities of the surfaces coming into contact and colliding with each other.

There are two types of friction to consider:

- **Static friction** is the force that opposes the start of relative motion between two objects in contact with each other.
- **Kinetic friction** is the force that opposes the relative motion between two objects in contact with each other when the objects are actually in motion.

Important things to know about friction:

1. Friction is always parallel to the contact surface and is in the opposite direction of the force causing the motion
2. Static friction is always greater than kinetic friction.
 - This is due to inertia – An object at rest tends to stay at rest while an object in motion tends to continue moving.
3. Friction increases as the force between two surfaces increases.
 - Friction depends on the nature of the materials coming into contact with each other.
 - Friction depends on the force pressing the objects together

Laws of Static Friction

Following are the laws of static friction :

1. The force of friction always acts in a direction, opposite to that in which the body tends to move.
2. The magnitude of the force of friction is exactly equal to the force, which tends the body to move.
3. The magnitude of the limiting friction (F) bears a constant ratio to the normal reaction (R_N) between the two surfaces. Mathematically
$$F/R_N = \text{constant}$$
4. The force of friction is independent of the area of contact, between the two surfaces.
5. The force of friction depends upon the roughness of the surfaces

Laws of Kinetic or Dynamic Friction

1. The force of friction always acts in a direction, opposite to that in which the body is moving.
2. The magnitude of the kinetic friction bears a constant ratio to the normal reaction between the two surfaces. But this ratio is slightly less than that in case of limiting friction.
3. For moderate speeds, the force of friction remains constant. But it decreases slightly with the increase of speed.

Laws of Solid Friction

1. The force of friction is directly proportional to the normal load between the surfaces.
2. The force of friction is independent of the area of the contact surface for a given normal load.
3. The force of friction depends upon the material of which the contact surfaces are made.
4. The force of friction is independent of the velocity of sliding of one body relative to the other body.

Laws of Fluid Friction

1. The force of friction is almost independent of the load.
2. The force of friction reduces with the increase of the temperature of the lubricant.
3. The force of friction is independent of the substances of the bearing surfaces.
4. The force of friction is different for different lubricants.

Coefficient of Friction

It is defined as the ratio of the limiting friction (F) to the normal reaction (R_N) between the two bodies. It is generally denoted by μ . Mathematically, coefficient of friction,

$$\mu = F/R_N$$

Angle of Repose

Consider that a body A of weight (W) is resting on an inclined plane B , as shown in Fig. 10.3. If the angle of inclination α of the plane to the horizontal is such that the body begins to move down the plane, then the angle ϕ is called the **angle of repose**.

A little consideration will show that the body will begin to move down the plane when the angle of inclination of the plane is equal to the angle of friction (*i.e.* $\alpha = \phi$). This may be proved as follows :

The weight of the body (W) can be resolved into the following two components :

1. $W \sin \alpha$, parallel to the plane B . This component tends to slide the body down the plane.
2. $W \cos \alpha$, perpendicular to the plane B . This component is balanced by the normal reaction (R_N) of the body A and the plane B . The body will only begin to move down the plane, when

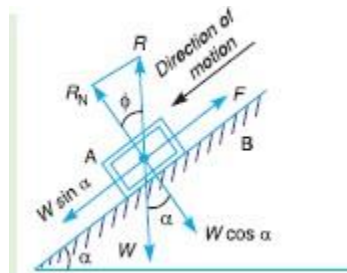

$$W \sin \alpha = F = \mu R_N = \mu W \cos \alpha$$

$$\tan \alpha = \mu = \tan \phi \quad \text{or} \quad \alpha = \phi$$

Screw Jack

The screw jack is a device, for lifting heavy loads, by applying a comparatively smaller effort at its handle. The principle, on which a screw jack works is similar to that of an inclined plane

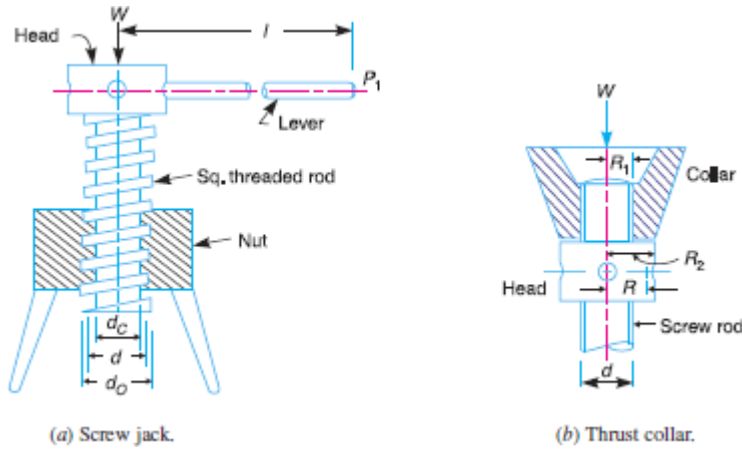
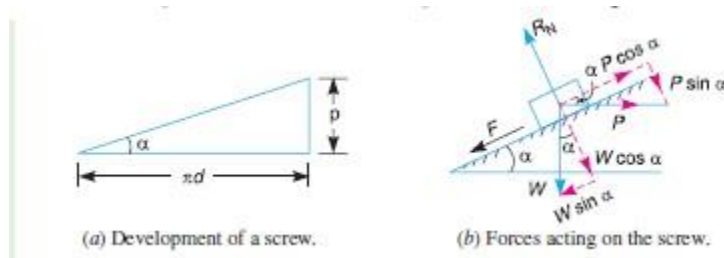

Fig (a) shows a common form of a screw jack, which consists of a square threaded rod (also called screw rod or simply screw) which fits into the inner threads of the nut. The load, to be raised or lowered, is placed on the head of the square threaded rod which is rotated by the application of an effort at the end of the lever for lifting or lowering the load.

Torque Required to Lift the Load by a Screw Jack

If one complete turn of a screw thread by imagined to be unwound, from the body of the screw and developed, it will form an inclined plane as shown in Fig



- p = Pitch of the screw,
- d = Mean diameter of the screw,
- α = Helix angle,
- P = Effort applied at the circumference of the screw to lift the load,
- W = Load to be lifted, and
- μ = Coefficient of friction, between the screw and nut = $\tan \phi$,
- where ϕ is the friction angle

$\tan \alpha = p/\pi d$

Resolving the forces along the plane,

$$P \cos \alpha = W \sin \alpha + F = W \sin \alpha + \mu \cdot R_N$$

and resolving the forces perpendicular to the plane,

$$R_N = P \sin \alpha + W \cos \alpha$$

Substituting this value of R_N in equation (i),

$$\begin{aligned} P \cos \alpha &= W \sin \alpha + \mu (P \sin \alpha + W \cos \alpha) \\ &= W \sin \alpha + \mu P \sin \alpha + \mu W \cos \alpha \end{aligned}$$

or $P \cos \alpha - \mu P \sin \alpha = W \sin \alpha + \mu W \cos \alpha$

or $P (\cos \alpha - \mu \sin \alpha) = W (\sin \alpha + \mu \cos \alpha)$

$$\therefore P = W \times \frac{\sin \alpha + \mu \cos \alpha}{\cos \alpha - \mu \sin \alpha}$$

Substituting the value of $\mu = \tan \phi$ in the above equation, we get

$$P = W \times \frac{\sin \alpha + \tan \phi \cos \alpha}{\cos \alpha - \tan \phi \sin \alpha}$$

Multiplying the numerator and denominator by $\cos \phi$,

$$P = W \times \frac{\sin \alpha \cos \phi + \sin \phi \cos \alpha}{\cos \alpha \cos \phi - \sin \alpha \sin \phi} = W \times \frac{\sin (\alpha + \phi)}{\cos (\alpha + \phi)}$$

$$= W \tan (\alpha + \phi)$$

\therefore Torque required to overcome friction between the screw and nut,

$$T_1 = P \times \frac{d}{2} = W \tan (\alpha + \phi) \frac{d}{2}$$

the axial load is taken up by a thrust collar or a flat surface, as shown in Fig.

so that the load does not rotate with the screw, then the torque required to overcome friction at the collar

$$T_2 = \mu_1 W \left(\frac{R_1 + R_2}{2} \right) = \mu_1 W R$$

R_1 and R_2 = Outside and inside radii of the collar,

R = Mean radius of the collar, and

μ_1 = Coefficient of friction for the collar.

\therefore Total torque required to overcome friction (*i.e.* to rotate the screw),

$$T = T_1 + T_2 = P \times \frac{d}{2} + \mu_1 W R$$

If an effort P_1 is applied at the end of a lever of arm length l , then the total torque required to overcome friction must be equal to the torque applied at the end of the lever, *i.e.*

$$T = P \times \frac{d}{2} = P_1 l$$

Example-1

A 150 mm diameter valve, against which a steam pressure of 2 MN/m² is acting, is closed by means of a square threaded screw 50 mm in external diameter with 6 mm pitch. If the coefficient of friction is 0.12 ; find the torque required to turn the handle.

Solution. Given : $D = 150 \text{ mm} = 0.15 \text{ m}$; $P_s = 2 \text{ MN/m}^2 = 2 \times 10^6 \text{ N/m}^2$;
 $d_0 = 50 \text{ mm}$; $p = 6 \text{ mm}$; $\mu = \tan \phi = 0.12$

We know that load on the valve,

$$W = \text{Pressure} \times \text{Area} = p_s \times \frac{\pi}{4} D^2 = 2 \times 10^6 \times \frac{\pi}{4} (0.15)^2 \text{ N}$$

$$= 35\,400 \text{ N}$$

Mean diameter of the screw,

$$d = d_0 - p/2 = 50 - 6/2 = 47 \text{ mm} = 0.047 \text{ m}$$

$$\therefore \tan \alpha = \frac{p}{\pi d} = \frac{6}{\pi \times 47} = 0.0406$$

We know that force required to turn the handle,

$$P = W \tan(\alpha + \phi) = W \left[\frac{\tan \alpha + \tan \phi}{1 - \tan \alpha \cdot \tan \phi} \right]$$

$$= 35\,400 \left[\frac{0.0406 + 0.12}{1 - 0.0406 \times 0.12} \right] = 57\,13 \text{ N}$$

\therefore Torque required to turn the handle,

$$T = P \times d/2 = 57\,13 \times 0.047/2 = 134.2 \text{ N-m Ans.}$$

Example-2

The cutter of a broaching machine is pulled by square threaded screw of 55 mm external diameter and 10 mm pitch. The operating nut takes the axial load of 400 N on a flatsurface of 60 mm internal diameter and 90 mm external diameter. If the coefficient of friction is 0.15 for all contact surfaces on the nut, determine the power required to rotate the operating nut, when the cutting speed is 6 m/min.

Solution. Given : $d_0 = 55 \text{ mm}$; $p = 10 \text{ mm} = 0.01 \text{ m}$; $W = 400 \text{ N}$; $D_2 = 60 \text{ mm}$ or
 $R_2 = 30 \text{ mm}$; $D_1 = 90 \text{ mm}$ or $R_1 = 45 \text{ mm}$; $\mu = \tan \phi = \mu_1 = 0.15$

We know that mean diameter of the screw,

$$d = d_0 - p/2 = 55 - 10/2 = 50 \text{ mm}$$

$$\therefore \tan \alpha = \frac{p}{\pi d} = \frac{10}{\pi \times 50} = 0.0637$$

and force required at the circumference of the screw,

$$P = W \tan(\alpha + \phi) = W \left[\frac{\tan \alpha + \tan \phi}{1 - \tan \alpha \cdot \tan \phi} \right]$$

$$= 400 \left[\frac{0.0637 + 0.15}{1 - 0.0637 \times 0.15} \right] = 86.4 \text{ N}$$

We know that mean radius of the flat surface,

$$R = \frac{R_1 + R_2}{2} = \frac{45 + 30}{2} = 37.5 \text{ mm}$$

\therefore Total torque required,

$$T = P \times \frac{d}{2} + \mu_1 W \cdot R = 86.4 \times \frac{50}{2} + 0.15 \times 400 \times 37.5 \text{ N-mm}$$

$$= 4410 \text{ N-mm} = 4.41 \text{ N-m} \quad \dots (\because \mu_1 = \mu)$$

Since the cutting speed is 6 m/min, therefore speed of the screw,

$$N = \frac{\text{Cutting speed}}{\text{Pitch}} = \frac{6}{0.01} = 600 \text{ r.p.m.}$$

and angular speed, $\omega = 2 \pi \times 600/60 = 62.84 \text{ rad/s}$

We know that power required to operate the nut

$$= T \cdot \omega = 4.41 \times 62.84 = 277 \text{ W} = 0.277 \text{ kW Ans.}$$

Torque Required to Lower the Load by a Screw Jack

If one complete turn of a screw thread be imagined to be unwound from the body of the screw and developed, it will form an inclined plane as shown in Fig.

Let p = Pitch of the screw,
 d = Mean diameter of the screw,
 α = Helix angle,
 P = Effort applied at the circumference of the screw to lower the load
 W = Load to be lifted, and
 μ = Coefficient of friction, between the screw and nut = $\tan \phi$,
 where ϕ is the friction angle

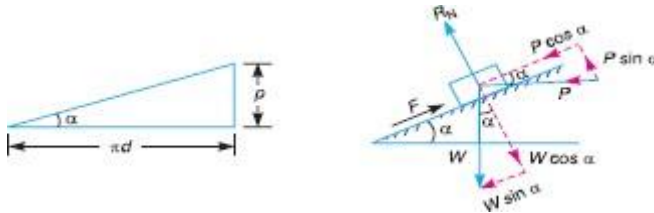

From the geometry of the figure, we find that

$$\tan \alpha = p/\pi d$$

Resolving the forces along the plane,

$$P \cos \alpha = F - W \sin \alpha = \mu R_N - W \sin \alpha$$

and resolving the forces perpendicular to the plane,

$$R_N = W \cos \alpha - P \sin \alpha$$

Substituting this value of R_N in equation (i),

$$P \cos \alpha = \mu (W \cos \alpha - P \sin \alpha) - W \sin \alpha$$

$$= \mu W \cos \alpha - \mu P \sin \alpha - W \sin \alpha$$

or $P \cos \alpha + \mu P \sin \alpha = \mu W \cos \alpha - W \sin \alpha$

or $P (\cos \alpha + \mu \sin \alpha) = W (\mu \cos \alpha - \sin \alpha)$

$$\therefore P = W \times \frac{(\mu \cos \alpha - \sin \alpha)}{(\cos \alpha + \mu \sin \alpha)}$$

Substituting the value of $\mu = \tan \phi$ in the above equation, we get

$$P = W \times \frac{(\tan \phi \cos \alpha - \sin \alpha)}{(\cos \alpha + \tan \phi \sin \alpha)}$$

Multiplying the numerator and denominator by $\cos \phi$,

$$P = W \times \frac{(\sin \phi \cos \alpha - \sin \alpha \cos \phi)}{(\cos \alpha \cos \phi + \sin \phi \sin \alpha)} = W \times \frac{\sin(\phi - \alpha)}{\cos(\phi - \alpha)}$$

$$= W \tan(\phi - \alpha)$$

\therefore Torque required to overcome friction between the screw and nut,

$$T = P \times \frac{d}{2} = W \tan(\phi - \alpha) \frac{d}{2}$$

Example-3

The mean diameter of a square threaded screw jack is 50 mm. The pitch of the thread is 10 mm. The coefficient of friction is 0.15. What force must be applied at the end of a 0.7 m long lever, which is perpendicular to the longitudinal axis of the screw to raise a load of 20 kN and to lower it?

Solution. Given : $d = 50 \text{ mm} = 0.05 \text{ m}$; $p = 10 \text{ mm}$; $\mu = \tan \phi = 0.15$; $l = 0.7 \text{ m}$; $W = 20 \text{ kN}$
 $= 20 \times 10^3 \text{ N}$

We know that $\tan \alpha = \frac{p}{\pi d} = \frac{10}{\pi \times 50} = 0.0637$

Let $P_1 =$ Force required at the end of the lever.

Force required to raise the load

We know that force required at the circumference of the screw,

$$P = W \tan(\alpha + \phi) = W \left[\frac{\tan \alpha + \tan \phi}{1 - \tan \alpha \tan \phi} \right]$$

$$= 20 \times 10^3 \left[\frac{0.0637 + 0.15}{1 - 0.0637 \times 0.15} \right] = 4314 \text{ N}$$

Now the force required at the end of the lever may be found out by the relation,

$$P_1 \times l = P \times \frac{d}{2}$$

$$\therefore P_1 = \frac{P \times d}{2l} = \frac{4314 \times 0.05}{2 \times 0.7} = 154 \text{ N Ans.}$$

Force required to lower the load

We know that the force required at the circumference of the screw,

$$P = W \tan(\phi - \alpha) = W \left[\frac{\tan \phi - \tan \alpha}{1 + \tan \phi \tan \alpha} \right]$$

$$= 20 \times 10^3 \left[\frac{0.15 - 0.0637}{1 + 0.15 \times 0.0637} \right] = 1710 \text{ N}$$

Now the force required at the end of the lever may be found out by the relation,

$$P_1 \times l = P \times \frac{d}{2} \text{ or } P_1 = \frac{P \times d}{2l} = \frac{1710 \times 0.05}{2 \times 0.7} = 61 \text{ N Ans.}$$

Efficiency of a Screw Jack

The efficiency of a screw jack may be defined as **the ratio between the ideal effort** (*i.e.* the effort required to move the load, neglecting friction) to **the actual effort** (*i.e.* the effort required to move the load taking friction into account).

We know that the effort required to lift the load (W) when friction is taken into account

$$P = W \tan(\alpha + \phi) \quad \dots(i)$$

$\alpha =$ Helix angle,

$\phi =$ Angle of friction, and

$\mu =$ Coefficient of friction, between the screw and nut $= \tan \phi$

If there would have been no friction between the screw and the nut, then ϕ will be equal to zero. The value of effort P_0 necessary to raise the load, will then be given by the equation

$$P_0 = W \tan \alpha$$

$$\therefore \text{Efficiency, } \eta = \frac{\text{Ideal effort}}{\text{Actual effort}} = \frac{P_0}{P} = \frac{W \tan \alpha}{W \tan(\alpha + \phi)} = \frac{\tan \alpha}{\tan(\alpha + \phi)}$$

Maximum Efficiency of a Screw Jack

$$\eta = \frac{\tan \alpha}{\tan(\alpha + \theta)} = \frac{\frac{\sin \alpha}{\cos \alpha}}{\frac{\sin(\alpha + \phi)}{\cos(\alpha + \phi)}} = \frac{\sin \alpha \times \cos(\alpha + \phi)}{\cos \alpha \times \sin(\alpha + \phi)}$$

$$= \frac{2 \sin \alpha \times \cos(\alpha + \phi)}{2 \cos \alpha \times \sin(\alpha + \phi)}$$

$$= \frac{\sin(2\alpha + \phi) - \sin \phi}{\sin(2\alpha + \phi) + \sin \phi}$$

$$\sin(2\alpha + \phi) = 1 \quad \text{or when } 2\alpha + \phi = 90^\circ$$

$$2\alpha = 90^\circ - \phi \quad \text{or } \alpha = 45^\circ - \phi/2$$

$$\eta_{\max} = \frac{\sin(90^\circ - \phi + \phi) - \sin \phi}{\sin(90^\circ - \phi + \phi) + \sin \phi} = \frac{\sin 90^\circ - \sin \phi}{\sin 90^\circ + \sin \phi} = \frac{1 - \sin \phi}{1 + \sin \phi}$$

Over Hauling and Self Locking Screws

$$P = W \tan(\phi - \alpha)$$

$$T = P \times \frac{d}{2} = W \tan(\phi - \alpha) \frac{d}{2}$$

In the above expression, if $\phi < \alpha$, then torque required to lower the load will be **negative**. In other words, the load will start moving downward without the application of any torque. Such a condition is known as **over hauling of screws**. If however, $\phi > \alpha$, the torque required to lower the load will be **positive**, indicating that an effort is applied to lower the load. Such a screw is known as **self locking screw**. In other words, a screw will be self locking if the friction angle is greater than helix angle or coefficient of friction is greater than tangent of helix angle i.e. μ or $\tan \phi > \tan \alpha$

Efficiency of Self Locking Screws

$$\eta = \frac{\tan \alpha}{\tan(\alpha + \phi)}$$

and for self locking screws, $\phi \geq \alpha$ or $\alpha \leq \phi$

∴ Efficiency of self locking screws,

$$\eta \leq \frac{\tan \phi}{\tan(\phi + \phi)} \leq \frac{\tan \phi}{\tan 2\phi} \leq \frac{\tan \phi(1 - \tan^2 \phi)}{2 \tan \phi}$$

$$\leq \frac{1 - \tan^2 \phi}{2} \quad \dots \left(\because \tan 2\phi = \frac{2 \tan \phi}{1 - \tan^2 \phi} \right)$$

From this expression we see that efficiency of self locking screws is less than $\frac{1}{2}$ or 50%. If the efficiency is more than 50%, then the screw is said to be overhauling.

BEARING

A **bearing** is a machine element that constrains relative motion to only the desired motion, and reduces friction between moving parts

classification

Depending upon the direction of the force

Radial bearing: Radial bearing supports the load which is perpendicular to the axis of the shaft

Thrust bearing: Thrust bearing supports the load which acts along the axis of the shaft

Depending upon the type of friction

Sliding contact bearing:In this type of bearings, the surface of the shaft slides over the surface of the bush. To prevent friction, both surfaces are separated by a thin film of lubricating oil. Generally, Bush is made from bronze or white metal.

Example: Plain bearing, journal bearing, sleeve bearing

Rolling contact bearing or anti-friction bearing:Here rolling friction comes into play. This bearing is also called anti-friction bearing as friction is negligible which is in range of 0.005 to 0.003 fR.C.

Example: Bearings used in automobile axle, gearbox, machine tool spindles, small electric motor

Types of rolling contact bearings

Deep groove ball bearing:In this type of bearings, the radius of the ball is slightly less than the radius of curvature of the groove. This creates point contact. Thus friction is less and so it can be used in high-speed applications. Due to low friction, temperature rise and the noise level is also low. It can take axial as well as radial loads.

Cylindrical roller bearing:These bearing are used where high load carrying capacity is required. Here rolling elements are cylindrical in shape instead of balls as in deep groove ball bearing. It gives line contact and same as previous case friction loss is less so it can be used in the high speed application. This bearing can not take thrust load.

Angular contact bearing:This type of bearing is designed in such a way that line of reaction at the point of contacts for a ball at the inner race and outer race, make an angle with the axis of the bearing. Due to this, it can take the radial and axial loads simultaneously. Load carrying capacity of such bearings is high compared to deep groove ball bearings. However, two bearings are required to take thrust load in both directions.

Self-aligning bearing:In this type of bearing, the external surface of the bearing bush is made spherical. The centre of this spherical surface is at the centre of the bearing so it can align itself with the journal. It is used to compensate any misalignment. It can take both radial and axial loads.



deep groove ball bearing



self-aligning roller bearing



cylindrical roller bearing



self-aligning ball bearing



bearing block



tapered roller bearing



thrust bearing



angular contact ball bearing



needle roller bearing

Taper roller bearing: Here rolling elements are rollers. They are arranged in such a way that axes of individual rolling elements intersect at a common point at the axis of the bearing. This is for the pure rolling motion.

Two bearings are required to take axial loads.

This type of bearings is commonly used in automobile, railway and machine tools.

Thrust ball bearing: Thrust ball bearing consist two row of balls. Balls, inner and outer race are made from high carbon chromium steel while the roller is made from case hardened steel. These bearings are generally used in the gearbox. Due to a large number of balls, it can take comparatively high thrust load. However,, it can take thrust loading single direction only

Friction in journal bearing

Let ϕ = Angle between R (resultant of F and R_N) and R_N ,
 μ = Coefficient of friction between the journal and bearing,
 T = Frictional torque in N-m, and
 r = Radius of the shaft in metres.

For uniform motion, the resultant force acting on the shaft must be zero and the resultant turning moment on the shaft must be zero. In other words,

$$R = W, \text{ and } T = W \times OC = W \times OB \sin \phi = W.r \sin \phi$$

Since ϕ is very small, therefore substituting $\sin \phi = \tan \phi$

$$\therefore T = W.r \tan \phi = \mu.W.r \quad \dots (\because \mu = \tan \phi)$$

If the shaft rotates with angular velocity ω rad/s, then power wasted in friction,

$$P = T.\omega = T \times 2\pi N/60 \text{ watts}$$

where N = Speed of the shaft in r.p.m.

Friction of Pivot Bearing

The bearing surfaces placed at the end of a shaft to take the axial thrust are known as **pivots**. The pivot may have a flat surface or conical surface. When the cone is truncated, it is then known as truncated or trapezoidal pivot.

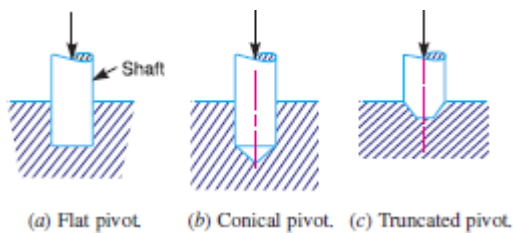

Consider the two condition for friction

1. The pressure is uniformly distributed throughout the bearing surface, and
2. The wear is uniform throughout the bearing surface

Friction of collar bearing

The collar may have flat bearing surface or conical bearing surface, but the flat surface is most commonly used. There may be a single collar, as shown in Fig. or several collars along the length of a shaft, as shown in Fig in order to reduce the intensity of pressure.

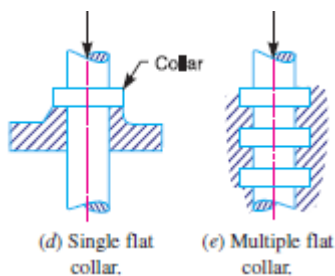

Flat Pivot Bearing

When a vertical shaft rotates in a flat pivot bearing as shown in Fig., the sliding friction will be along the surface of contact between the shaft and the bearing.

Let W = Load transmitted over the bearing surface,

R = Radius of bearing surface,

p = Intensity of pressure per unit area of bearing surface between rubbing surfaces, and

μ = Coefficient of friction.

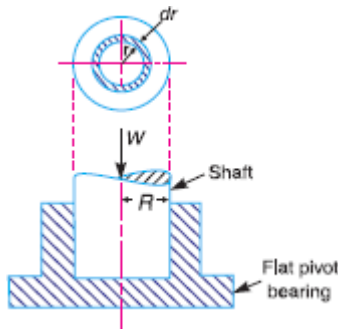

We will consider the following two cases :

1. When there is a uniform pressure

When the pressure is uniformly distributed over the bearing area, then

$$p = \frac{W}{\pi R^2}$$

Consider a ring of radius r and thickness dr of the bearing area.

\therefore Area of bearing surface, $A = 2\pi r \cdot dr$

Load transmitted to the ring,

$$\delta W = p \times A = p \times 2\pi r \cdot dr \quad \dots(i)$$

Frictional resistance to sliding on the ring acting tangentially at radius r ,

$$F_r = \mu \cdot \delta W = \mu p \times 2\pi r \cdot dr = 2\pi \mu \cdot p \cdot r \cdot dr$$

\therefore Frictional torque on the ring,

$$T_r = F_r \times r = 2\pi \mu p r \cdot dr \times r = 2\pi \mu p r^2 dr \quad \dots(ii)$$

Integrating this equation within the limits from 0 to R for the total frictional torque on the pivot bearing,

$$\begin{aligned} \therefore \text{Total frictional torque, } T &= \int_0^R 2\pi \mu p r^2 dr = 2\pi \mu p \int_0^R r^2 dr \\ &= 2\pi \mu p \left[\frac{r^3}{3} \right]_0^R = 2\pi \mu p \times \frac{R^3}{3} = \frac{2}{3} \times \pi \mu \cdot p \cdot R^3 \\ &= \frac{2}{3} \times \pi \mu \times \frac{W}{\pi R^2} \times R^3 = \frac{2}{3} \times \mu \cdot W \cdot R \quad \dots \left(\because p = \frac{W}{\pi R^2} \right) \end{aligned}$$

When the shaft rotates at ω rad/s, then power lost in friction,

$$P = T \cdot \omega = T \times 2\pi N/60 \quad \dots (\because \omega = 2\pi N/60)$$

where

N = Speed of shaft in r.p.m.

2. When there is a uniform wear

wear

$$p \cdot r = C \text{ (a constant) or } p = C / r$$

and the load transmitted to the ring,

$$\delta W = p \times 2\pi r \cdot dr \quad \dots[\text{From equation (i)}]$$

$$= \frac{C}{r} \times 2\pi r \cdot dr = 2\pi C \cdot dr$$

∴ Total load transmitted to the bearing

$$W = \int_0^R 2\pi C \cdot dr = 2\pi C [r]_0^R = 2\pi C \cdot R \text{ or } C = \frac{W}{2\pi R}$$

We know that frictional torque acting on the ring,

$$T_f = 2\pi \mu p r^2 \cdot dr = 2\pi \mu \times \frac{C}{r} \times r^2 \cdot dr \quad \dots\left(\because p = \frac{C}{r}\right)$$

$$= 2\pi \mu \cdot C \cdot r \cdot dr \quad \dots(iii)$$

∴ Total frictional torque on the bearing,

$$T = \int_0^R 2\pi \mu \cdot C \cdot r \cdot dr = 2\pi \mu \cdot C \left[\frac{r^2}{2} \right]_0^R$$

$$= 2\pi \mu \cdot C \times \frac{R^2}{2} = \pi \mu \cdot C \cdot R^2$$

$$= \pi \mu \times \frac{W}{2\pi R} \times R^2 = \frac{1}{2} \times \mu \cdot W \cdot R \quad \dots\left(\because C = \frac{W}{2\pi R}\right)$$

Conical Pivot Bearing

The conical pivot bearing supporting a shaft carrying a load W is shown in Fig

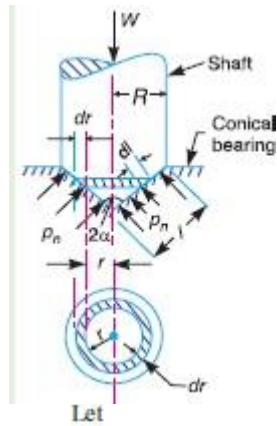

- Let P_n = Intensity of pressure normal to the cone,
- α = Semi angle of the cone,
- μ = Coefficient of friction between the shaft and the bearing, and
- R = Radius of the shaft.

Consider a small ring of radius r and thickness dr . Let dl is the length of ring along the cone, such that

$$dl = dr \operatorname{cosec} \alpha$$

∴ Area of the ring,

$$A = 2\pi r \cdot dl = 2\pi r \cdot dr \operatorname{cosec} \alpha$$

...($\because dl = dr \operatorname{cosec} \alpha$)

Consider uniform condition

We know that normal load acting on the ring,

$$\begin{aligned} \delta W_n &= \text{Normal pressure} \times \text{Area} \\ &= p_n \times 2\pi r \cdot dr \operatorname{cosec} \alpha \end{aligned}$$

and vertical load acting on the ring,

$$\begin{aligned} \delta W &= \text{Vertical component of } \delta W_n = \delta W_n \cdot \sin \alpha \\ &= p_n \times 2\pi r \cdot dr \operatorname{cosec} \alpha \cdot \sin \alpha = p_n \times 2\pi r \cdot dr \end{aligned}$$

∴ Total vertical load transmitted to the bearing,

$$W = \int_0^R p_n \times 2\pi r \cdot dr = 2\pi p_n \left[\frac{r^2}{2} \right]_0^R = 2\pi p_n \times \frac{R^2}{2} = \pi R^2 \cdot p_n$$

or

$$p_n = W / \pi R^2$$

We know that frictional force on the ring acting tangentially at radius r ,

$$F_r = \mu \cdot \delta W_n = \mu \cdot p_n \cdot 2\pi r \cdot dr \operatorname{cosec} \alpha = 2\pi \mu \cdot p_n \cdot \operatorname{cosec} \alpha \cdot r \cdot dr$$

and frictional torque acting on the ring,

$$T_r = F_r \times r = 2\pi \mu \cdot p_n \cdot \operatorname{cosec} \alpha \cdot r \cdot dr \times r = 2\pi \mu \cdot p_n \cdot \operatorname{cosec} \alpha \cdot r^2 \cdot dr$$

Integrating the expression within the limits from 0 to R for the total frictional torque on the conical pivot bearing,

∴ Total frictional torque,

$$\begin{aligned} T &= \int_0^R 2\pi \mu \cdot p_n \cdot \operatorname{cosec} \alpha \cdot r^2 \cdot dr = 2\pi \mu \cdot p_n \cdot \operatorname{cosec} \alpha \left[\frac{r^3}{3} \right]_0^R \\ &= 2\pi \mu \cdot p_n \cdot \operatorname{cosec} \alpha \times \frac{R^3}{3} = \frac{2\pi R^3}{3} \times \mu \cdot p_n \cdot \operatorname{cosec} \alpha \quad \dots (i) \end{aligned}$$

Substituting the value of p_n in equation (i),

$$T = \frac{2\pi R^3}{3} \times \pi \times \frac{W}{\pi R^2} \times \operatorname{cosec} \alpha = \frac{2}{3} \times \mu \cdot W \cdot R \cdot \operatorname{cosec} \alpha$$

Considering uniform wear

let p_r be the normal intensity of pressure at a distance r from the central axis.

We know that, in case of uniform wear, the intensity of pressure varies inversely with the distance

$$\therefore p_r \cdot r = C \text{ (a constant) or } p_r = Cr$$

and the load transmitted to the ring,

$$\delta W = p_r \times 2\pi r \cdot dr = \frac{C}{r} \times 2\pi r \cdot dr = 2\pi C \cdot dr$$

∴ Total load transmitted to the bearing,

$$W = \int_0^R 2\pi C \cdot dr = 2\pi C \left[r \right]_0^R = 2\pi C \cdot R \text{ or } C = \frac{W}{2\pi R}$$

$$\begin{aligned} T_r &= 2\pi \mu \cdot p_r \cdot \operatorname{cosec} \alpha \cdot r^2 \cdot dr = 2\pi \mu \times \frac{C}{r} \times \operatorname{cosec} \alpha \cdot r^2 \cdot dr \\ &= 2\pi \mu \cdot C \cdot \operatorname{cosec} \alpha \cdot r \cdot dr \end{aligned}$$

∴ Total frictional torque acting on the bearing,

$$\begin{aligned} T &= \int_0^R 2\pi \mu \cdot C \cdot \operatorname{cosec} \alpha \cdot r \cdot dr = 2\pi \mu \cdot C \cdot \operatorname{cosec} \alpha \left[\frac{r^2}{2} \right]_0^R \\ &= 2\pi \mu \cdot C \cdot \operatorname{cosec} \alpha \times \frac{R^2}{2} = \pi \mu \cdot C \cdot \operatorname{cosec} \alpha \cdot R^2 \end{aligned}$$

Substituting the value of C , we have

$$T = \pi \mu \times \frac{W}{2\pi R} \times \operatorname{cosec} \alpha \cdot R^2 = \frac{1}{2} \times \mu \cdot W \cdot R \operatorname{cosec} \alpha = \frac{1}{2} \times \mu \cdot W \cdot l$$

Flat Collar Bearing

collar bearings are used to take the axial thrust of the rotating shafts. There may be a single collar or multiple collar bearings as shown in Fig. The collar bearings are also known as **thrust bearings**.

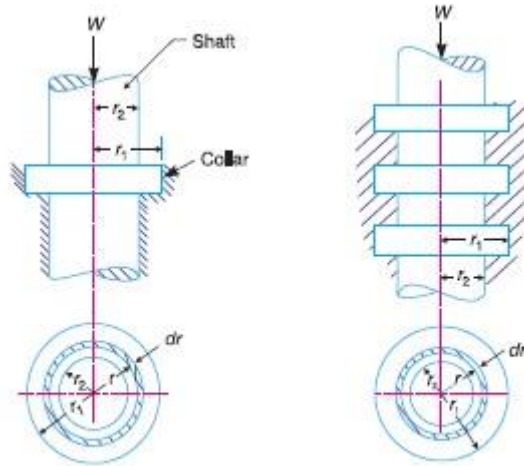

(a) Single collar bearing (b) Multiple collar bearing.

Consider a single flat collar bearing supporting a shaft as shown in Fig.

Let r_1 = External radius of the collar, and
 r_2 = Internal radius of the collar.

∴ Area of the bearing surface,

$$A = \pi [(r_1)^2 - (r_2)^2]$$

Considering uniform pressure

When the pressure is uniformly distributed over the bearing surface, then the intensity of pressure,

$$p = \frac{W}{A} = \frac{W}{\pi[(r_1)^2 - (r_2)^2]} \quad \dots(i)$$

We have seen in Art. 10.25, that the frictional torque on the ring of radius r and thickness dr ,

$$T_r = 2\pi\mu.p.r^2.dr$$

Integrating this equation within the limits from r_2 to r_1 for the total frictional torque on the collar.

∴ Total frictional torque,

$$T = \int_{r_2}^{r_1} 2\pi\mu.p.r^2.dr = 2\pi\mu.p \left[\frac{r^3}{3} \right]_{r_2}^{r_1} = 2\pi\mu.p \left[\frac{(r_1)^3 - (r_2)^3}{3} \right]$$

Substituting the value of p from equation (i),

$$T = 2\pi\mu \times \frac{W}{\pi[(r_1)^2 - (r_2)^2]} \left[\frac{(r_1)^3 - (r_2)^3}{3} \right]$$

$$= \frac{2}{3} \times \mu.W \left[\frac{(r_1)^3 - (r_2)^3}{(r_1)^2 - (r_2)^2} \right]$$

Considering unifrom wear

$$\delta W = p_r \cdot 2\pi r \cdot dr = \frac{C}{r} \times 2\pi r \cdot dr = 2\pi C \cdot dr$$

∴ Total load transmitted to the collar,

$$W = \int_{r_2}^{r_1} 2\pi C \cdot dr = 2\pi C [r]_{r_2}^{r_1} = 2\pi C (r_1 - r_2)$$

or

$$C = \frac{W}{2\pi(r_1 - r_2)} \quad \dots(ii)$$

We also know that frictional torque on the ring,

$$T_r = \mu \cdot \delta W \cdot r = \mu \times 2\pi C \cdot dr \cdot r = 2\pi\mu C \cdot r \cdot dr$$

∴ Total frictional torque on the bearing,

$$\begin{aligned} T &= \int_{r_2}^{r_1} 2\pi\mu C \cdot r \cdot dr = 2\pi\mu C \left[\frac{r^2}{2} \right]_{r_2}^{r_1} = 2\pi\mu C \left[\frac{(r_1)^2 - (r_2)^2}{2} \right] \\ &= \pi\mu C [(r_1)^2 - (r_2)^2] \end{aligned}$$

Substituting the value of C from equation (ii),

$$T = \pi\mu \times \frac{W}{2\pi(r_1 - r_2)} [(r_1)^2 - (r_2)^2] = \frac{1}{2} \times \mu \cdot W (r_1 + r_2)$$

Module -3

Introduction

The power is transmitted from one shaft to the other by means of belts, chains and gears. The belts and ropes are flexible members which are used where distance between the two shafts is large. The chains also have flexibility but they are preferred for intermediate distances. The gears are used when the shafts are very close with each other. This type of drive is also called positive drive because there is no slip. If the distance is slightly larger, chain drive can be used for making it a positive drive. Belts and ropes transmit power due to the friction between the belt or rope and the pulley. There is a possibility of slip and creep and that is why, this drive is not a positive drive. A gear train is a combination of gears which are used for transmitting motion from one shaft to another.

Power Transmission Devices

Power transmission devices are very commonly used to transmit power from one shaft to another. Belts, chains and gears are used for this purpose. When the distance between the shafts is large, belts or ropes are used and for intermediate distance chains can be used. For belt drive distance can be maximum but this should not be more than ten metres for good results. Gear drive is used for short distances.

Belts

In case of belts, friction between the belt and pulley is used to transmit power. In practice, there is always some amount of slip between belt and pulleys, therefore, exact velocity ratio cannot be obtained. That is why, belt drive is not a positive drive. Therefore, the belt drive is used where exact velocity ratio is not required.

The flat belt is rectangular in cross-section. The pulley for this belt is slightly crowned to prevent slip of the belt to one side. It utilizes the friction between the flat surface of the belt and pulley.

The V-belt is trapezoidal in section. It utilizes the force of friction between the inclined sides of the belt and pulley. They are preferred when distance is comparative shorter. Several V-belts can also be used together if power transmitted is more.

The circular belt or rope is circular in section. Several ropes also can be used together to transmit more power.

The belt drives are of the following types :

- (a) open belt drive, and
- (b) cross belt drive.

Open Belt drive

Open belt drive is used when sense of rotation of both the pulleys is same. It is desirable to keep the tight side of the belt on the lower side and slack side at the top to increase the angle of contact on the pulleys. This type of drive

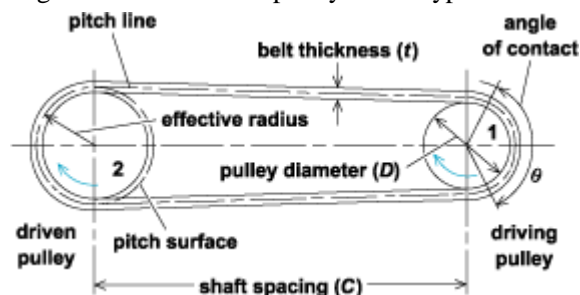

Cross Belt Drive

In case of cross belt drive, the pulleys rotate in the opposite direction. The angle of contact of belt on both the pulleys is equal., the belt has to bend in two different planes. As a result of this, belt wears very fast and therefore, this type of drive is not preferred for power transmission. This can be used for transmission of speed at low power.

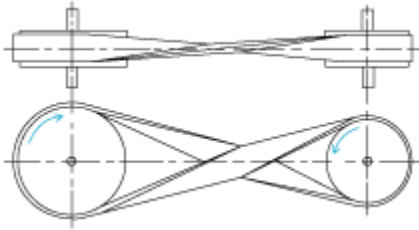

Since power transmitted by a belt drive is due to the friction, belt drive is subjected to slip and creep.

Velocity ratio of belt drive

It is the **ratio between the velocities of the driver and the follower or driven.**

Let d_1 and d_2 be the diameters of driving and driven pulleys, respectively.

N_1 and N_2 be the corresponding speeds of driving and driven pulleys, respectively.

The velocity of the belt passing over the driver

$$V_1 = \pi d_1 N_1 / 60$$

If there is no slip between the belt and p

$$V_1 = V_2 = \pi d_2 N_2 / 60$$

Or, $\pi d_1 N_1 / 60 = \pi d_2 N_2 / 60$

Or, $N_1 / N_2 = d_2 / d_1$

If thickness of the belt is 't', and it is not negligible in comparison to the diameter,

Or, $N_1 / N_2 = d_2 + t / d_1 + t$

Let there be total percentage slip 'S' in the belt drive which can be taken into account as follows

$$V_2 = V_1 (1 - S/100)$$

$$\pi d_2 N_2 / 60 = \pi d_1 N_1 / 60 (1 - S/100)$$

If the thickness of belt is also to be considered

$$N_1 / N_2 = d_2 + t / d_1 + t * 1 / (1 - S/100)$$

$$N_2 / N_1 = d_1 + t / d_2 + t * (1 - S/100)$$

The belt moves from the tight side to the slack side and vice-versa, there is some loss of power because the length of belt continuously extends on tight side and contracts on loose side. Thus, there is relative motion between the belt and pulley due to body slip. This is known as **creep**.

Length of open belt drive

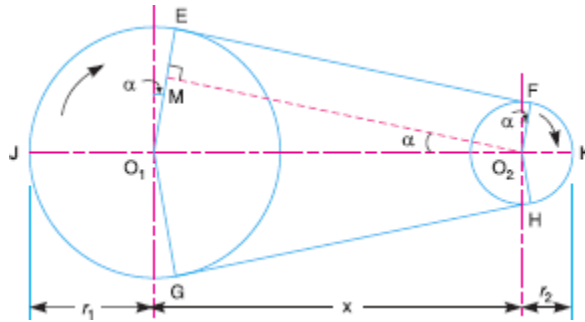

We have already discussed in Art. 11.6 that in an open belt drive, both the pulleys rotate in the **same** direction as shown in Fig. 11.11.

- Let r_1 and r_2 = Radii of the larger and smaller pulleys,
- x = Distance between the centres of two pulleys (i.e. $O_1 O_2$), and
- L = Total length of the belt.

Let the belt leaves the larger pulley at E and G and the smaller pulley at F and H as shown in Fig. 11.11. Through O_2 , draw $O_2 M$ parallel to FE .

From the geometry of the figure, we find that $O_2 M$ will be perpendicular to $O_1 E$.

Let the angle $MO_2 O_1 = \alpha$ radians.

We know that the length of the belt,

$$L = \text{Arc } GJE + EF + \text{Arc } FKH + HG$$

$$= 2 (\text{Arc } JE + EF + \text{Arc } FK) \tag{i}$$

From the geometry of the figure, we find that

$$\sin \alpha = \frac{O_1 M}{O_1 O_2} = \frac{O_1 E - EM}{O_1 O_2} = \frac{r_1 - r_2}{x}$$

Since α is very small, therefore putting

$$\sin \alpha = \alpha \text{ (in radians)} = \frac{r_1 - r_2}{x} \tag{ii}$$

$$\therefore \text{Arc } JE = r_1 \left(\frac{\pi}{2} + \alpha \right) \tag{iii}$$

$$\text{Similarly Arc } FK = r_2 \left(\frac{\pi}{2} - \alpha \right) \tag{iv}$$

and
$$EF = MO_2 = \sqrt{(O_1 O_2)^2 - (O_1 M)^2} = \sqrt{x^2 - (r_1 - r_2)^2}$$

$$= x \sqrt{1 - \left(\frac{r_1 - r_2}{x} \right)^2}$$

Expanding this equation by binomial theorem,

$$EF = x \left[1 - \frac{1}{2} \left(\frac{r_1 - r_2}{x} \right)^2 + \dots \right] = x - \frac{(r_1 - r_2)^2}{2x} \tag{v}$$

Substituting the values of arc JE from equation (iii), arc FK from equation (iv) and EF from equation (v) in equation (i), we get

$$L = 2 \left[r_1 \left(\frac{\pi}{2} + \alpha \right) + x - \frac{(r_1 - r_2)^2}{2x} + r_2 \left(\frac{\pi}{2} - \alpha \right) \right]$$

$$= 2 \left[r_1 \times \frac{\pi}{2} + r_1 \cdot \alpha + x - \frac{(r_1 - r_2)^2}{2x} + r_2 \times \frac{\pi}{2} - r_2 \cdot \alpha \right]$$

$$= 2 \left[\frac{\pi}{2} (r_1 + r_2) + \alpha (r_1 - r_2) + x - \frac{(r_1 - r_2)^2}{2x} \right]$$

$$= \pi (r_1 + r_2) + 2\alpha (r_1 - r_2) + 2x - \frac{(r_1 - r_2)^2}{x}$$

Substituting the value of $\alpha = \frac{r_1 - r_2}{x}$ from equation (ii),

$$L = \pi (r_1 + r_2) + 2 \times \frac{(r_1 - r_2)}{x} \times (r_1 - r_2) + 2x - \frac{(r_1 - r_2)^2}{x}$$

$$= \pi (r_1 + r_2) + \frac{2(r_1 - r_2)^2}{x} + 2x - \frac{(r_1 - r_2)^2}{x}$$

$$= \pi (r_1 + r_2) + 2x + \frac{(r_1 - r_2)^2}{x} \quad \dots(\text{In terms of pulley radii})$$

$$= \frac{\pi}{2} (d_1 + d_2) + 2x + \frac{(d_1 - d_2)^2}{4x} \quad \dots(\text{In terms of pulley diameters})$$

Length of a Cross Belt Drive

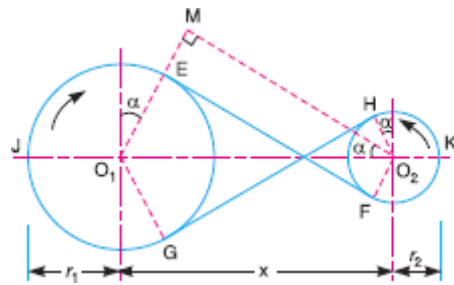

- Let r_1 and r_2 = Radii of the larger and smaller pulleys,
- x = Distance between the centres of two pulleys (i.e. $O_1 O_2$), and
- L = Total length of the belt.

Fig. 11.12. Through O_2 , draw O_2M parallel to FE .

From the geometry of the figure, we find that O_2M will be perpendicular to O_1E .

Let the angle $MO_2 O_1 = \alpha$ radians.

We know that the length of the belt,

$$L = \text{Arc } GJE + EF + \text{Arc } FKH + HG$$

$$= 2 (\text{Arc } JE + EF + \text{Arc } FK) \quad \dots(i)$$

From the geometry of the figure, we find that

$$\sin \alpha = \frac{O_1 M}{O_1 O_2} = \frac{O_1 E + EM}{O_1 O_2} = \frac{r_1 + r_2}{x}$$

Since α is very small, therefore putting

$$\sin \alpha = \alpha \text{ (in radians)} = \frac{r_1 + r_2}{x} \quad \dots(ii)$$

$$\therefore \text{Arc } JE = r_1 \left(\frac{\pi}{2} + \alpha \right) \quad \dots(iii)$$

$$\text{Similarly Arc } FK = r_2 \left(\frac{\pi}{2} + \alpha \right) \quad \dots(iv)$$

and

$$EF = MO_2 = \sqrt{(O_1 O_2)^2 - (O_1 M)^2} = \sqrt{x^2 - (r_1 + r_2)^2}$$

$$= x \sqrt{1 - \left(\frac{r_1 + r_2}{x} \right)^2}$$

Expanding this equation by binomial theorem,

$$EF = x \left[1 - \frac{1}{2} \left(\frac{r_1 + r_2}{x} \right)^2 + \dots \right] = x - \frac{(r_1 + r_2)^2}{2x} \quad \dots(v)$$

Substituting the values of arc JE from equation (iii), arc FK from equation (iv) and EF from equation (v) in equation (i), we get

$$\begin{aligned} L &= 2 \left[r_1 \left(\frac{\pi}{2} + \alpha \right) + x - \frac{(r_1 + r_2)^2}{2x} + r_2 \left(\frac{\pi}{2} + \alpha \right) \right] \\ &= 2 \left[r_1 \times \frac{\pi}{2} + r_1 \cdot \alpha + x - \frac{(r_1 + r_2)^2}{2x} + r_2 \times \frac{\pi}{2} + r_2 \cdot \alpha \right] \\ &= 2 \left[\frac{\pi}{2} (r_1 + r_2) + \alpha (r_1 + r_2) + x - \frac{(r_1 + r_2)^2}{2x} \right] \\ &= \pi (r_1 + r_2) + 2\alpha (r_1 + r_2) + 2x - \frac{(r_1 + r_2)^2}{x} \end{aligned}$$

Substituting the value of $\alpha = \frac{r_1 + r_2}{x}$ from equation (ii),

$$\begin{aligned} L &= \pi (r_1 + r_2) + \frac{2(r_1 + r_2)}{x} \times (r_1 + r_2) + 2x - \frac{(r_1 + r_2)^2}{x} \\ &= \pi (r_1 + r_2) + \frac{2(r_1 + r_2)^2}{x} + 2x - \frac{(r_1 + r_2)^2}{x} \\ &= \pi (r_1 + r_2) + 2x + \frac{(r_1 + r_2)^2}{x} \quad \dots(\text{In terms of pulley radii}) \\ &= \frac{\pi}{2} (d_1 + d_2) + 2x + \frac{(d_1 + d_2)^2}{4x} \quad \dots(\text{In terms of pulley diameters}) \end{aligned}$$

Power Transmitted by a Belt

the driving pulley (or driver) A and the driven pulley (or follower) B . We have already discussed that the driving pulley pulls the belt from one side and delivers the same to the other side. It is thus obvious that the tension on the former side (*i.e.* tight side) will be greater than the latter side (*i.e.* slack side)

T_1 and T_2 = Tensions in the tight and slack side of the belt respectively in newtons,
 r_1 and r_2 = Radii of the driver and follower respectively, and
 v = Velocity of the belt in m/s.

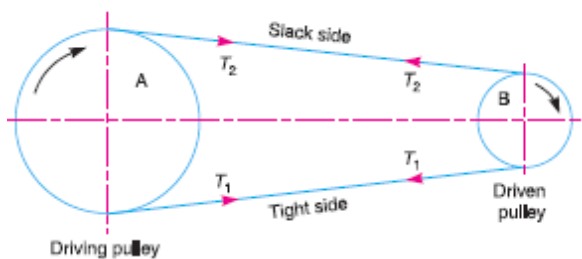

The effective turning (driving) force at the circumference of the follower is the difference between the two tensions (i.e. $T_1 - T_2$).

∴ Work done per second = $(T_1 - T_2) v$ N-m/s

and power transmitted, $P = (T_1 - T_2) v$ W ... (∵ 1 N-m/s = 1 W)

Ratio of Driving Tensions For Flat Belt Drive

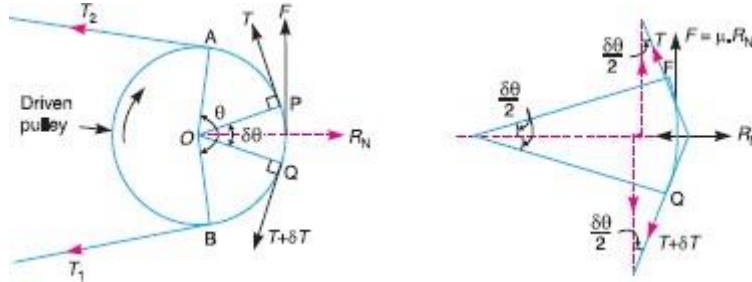

T_1 = Tension in the belt on the tight side,

T_2 = Tension in the belt on the slack side, and

θ = Angle of contact in radians (i.e. angle subtended by the arc AB, along which the belt touches the pulley at the centre).

Now consider a small portion of the belt PQ, subtending an angle θ at the centre of the pulley. The belt PQ is in equilibrium under the following forces

1. Tension T in the belt at P,
2. Tension $(T + \delta T)$ in the belt at Q,
3. Normal reaction R_N , and
4. Frictional force, $F = \mu \times R_N$, where μ is the coefficient of friction between the belt and pulley.

Resolving all the forces horizontally and equating the same,

$$R_N = (T + \delta T) \sin \frac{\delta\theta}{2} + T \sin \frac{\delta\theta}{2} \tag{i}$$

Since the angle $\delta\theta$ is very small, therefore putting $\sin \delta\theta / 2 = \delta\theta / 2$ in equation (i),

$$R_N = (T + \delta T) \frac{\delta\theta}{2} + T \times \frac{\delta\theta}{2} = \frac{T \cdot \delta\theta}{2} + \frac{\delta T \cdot \delta\theta}{2} + \frac{T \cdot \delta\theta}{2} = T \cdot \delta\theta \tag{ii}$$

... (Neglecting $\frac{\delta T \cdot \delta\theta}{2}$)

Now resolving the forces vertically, we have

$$\mu \times R_N = (T + \delta T) \cos \frac{\delta\theta}{2} - T \cos \frac{\delta\theta}{2} \quad \dots(iii)$$

Since the angle $\delta\theta$ is very small, therefore putting $\cos \delta\theta / 2 = 1$ in equation (iii),

$$\mu \times R_N = T + \delta T - T = \delta T \text{ or } R_N = \frac{\delta T}{\mu} \quad \dots(iv)$$

Equating the values of R_N from equations (ii) and (iv),

$$T \cdot \delta\theta = \frac{\delta T}{\mu} \text{ or } \frac{\delta T}{T} = \mu \cdot \delta\theta$$

Integrating both sides between the limits T_2 and T_1 and from 0 to θ respectively,

$$i.e. \int_{T_2}^{T_1} \frac{\delta T}{T} = \mu \int_0^\theta \delta\theta \quad \text{or} \quad \log_e \left(\frac{T_1}{T_2} \right) = \mu \cdot \theta \text{ or } \frac{T_1}{T_2} = e^{\mu \cdot \theta} \quad \dots(v)$$

Equation (v) can be expressed in terms of corresponding logarithm to the base 10, i.e.

$$2.3 \log \left(\frac{T_1}{T_2} \right) = \mu \cdot \theta$$

Centrifugal Tension

the belt continuously runs over the pulleys, therefore, some centrifugal force is caused, whose effect is to increase the tension on both, tight as well as the slack sides. The tension caused by centrifugal force is called **centrifugal tension**. At lower belt speeds (less than 10 m/s), the centrifugal tension is very small, but at higher belt speeds (more than 10 m/s), its effect is considerable and thus should be taken into account.

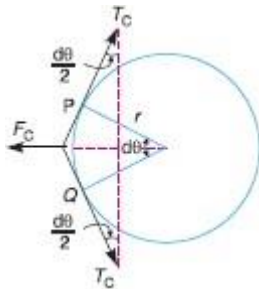

Let m = Mass of the belt per unit length in kg,
 v = Linear velocity of the belt in m/s,

r = Radius of the pulley over which the belt runs in metres, and
 T_C = Centrifugal tension acting tangentially at P and Q in newtons.

We know that length of the belt PQ

$$= r \cdot d\theta$$

and mass of the belt PQ

$$= m \cdot r \cdot d\theta$$

\therefore Centrifugal force acting on the belt PQ ,

$$F_C = (m \cdot r \cdot d\theta) \frac{v^2}{r} = m \cdot d\theta \cdot v^2$$

The centrifugal tension T_C acting tangentially at P and Q keeps the belt in equilibrium.

Now resolving the forces (*i.e.* centrifugal force and centrifugal tension) horizontally and equating the same, we have

$$T_C \sin\left(\frac{d\theta}{2}\right) + T_C \sin\left(\frac{d\theta}{2}\right) = F_C = m \cdot d\theta \cdot v^2$$

Since the angle $d\theta$ is very small, therefore, putting $\sin\left(\frac{d\theta}{2}\right) = \frac{d\theta}{2}$, in the above expression,

$$2T_C \left(\frac{d\theta}{2}\right) = m \cdot d\theta \cdot v^2 \quad \text{or} \quad T_C = m \cdot v^2$$

Maximum Tension in the Belt

A little consideration will show that the maximum tension in the belt (T) is equal to the total tension in the tight side of the belt (T_1).

Let σ = Maximum safe stress in N/mm^2 ,
 b = Width of the belt in mm, and
 t = Thickness of the belt in mm.

We know that maximum tension in the belt,

$$T = \text{Maximum stress} \times \text{cross-sectional area of belt} = \sigma \cdot b \cdot t$$

When centrifugal tension is neglected, then

$$T \text{ (or } T_1) = T_1, \text{ i.e. Tension in the tight side of the belt}$$

and when centrifugal tension is considered, then

$$T \text{ (or } T_1) = T_1 + T_C$$

Condition For the Transmission of Maximum Power

We know that power transmitted by a belt,

$$P = (T_1 - T_2) v \quad \dots(i)$$

where

T_1 = Tension in the tight side of the belt in newtons,

T_2 = Tension in the slack side of the belt in newtons, and

v = Velocity of the belt in m/s.

From Art. 11.14, we have also seen that the ratio of driving tensions is

$$\frac{T_1}{T_2} = e^{\mu \cdot \theta} \quad \text{or} \quad T_2 = \frac{T_1}{e^{\mu \cdot \theta}} \quad \dots(ii)$$

Substituting the value of T_2 in equation (i),

$$P = \left(T_1 - \frac{T_1}{e^{\mu \cdot \theta}}\right) v = T_1 \left(1 - \frac{1}{e^{\mu \cdot \theta}}\right) v = T_1 \cdot v \cdot C \quad \dots(iii)$$

where $C = 1 - \frac{1}{e^{\mu \theta}}$

We know that $T_1 = T - T_C$

where $T =$ Maximum tension to which the belt can be subjected in newtons, and
 $T_C =$ Centrifugal tension in newtons.

Substituting the value of T_1 in equation (iii),
 $P = (T - T_C) v . C$
 $= (T - m . v^2) v . C = (T . v - m v^3) C$... (Substituting $T_C = m . v^2$)

For maximum power, differentiate the above expression with respect to v and equate to zero,
i.e.

$\frac{dP}{dv} = 0$ or $\frac{d}{dv}(T . v - m v^3) C = 0$

$\therefore T - 3 m . v^2 = 0$

or $T - 3 T_C = 0$ or $T = 3 T_C$... (iv)

It shows that when the power transmitted is maximum, 1/3rd of the maximum tension is absorbed as centrifugal tension.

Initial Tension in the Belt

When a belt is wound round the two pulleys (*i.e.* driver and follower), its two ends are joined together ; so that the belt may continuously move over the pulleys, since the motion of the belt from the driver and the follower is governed by a firm grip, due to friction between the belt and the pulleys.

In order to increase this grip, the belt is tightened up. At this stage, even when the pulleys are stationary, the belt is subjected to some tension, called **initial tension**.

When the driver starts rotating, it pulls the belt from one side (increasing tension in the belt on this side) and delivers it to the other side (decreasing the tension in the belt on that side). The increased tension in one side of the belt is called tension in tight side and the decreased tension in the other side of the belt is called tension in the slack side.

Let T_0 = Initial tension in the belt,
 T_1 = Tension in the tight side of the belt,
 T_2 = Tension in the slack side of the belt, and
 α = Coefficient of increase of the belt length per unit force.

A little consideration will show that the increase of tension in the tight side
 $= T_1 - T_0$

and increase in the length of the belt on the tight side
 $= \alpha(T_1 - T_0)$...**(i)**

Similarly, decrease in tension in the slack side
 $= T_0 - T_2$

and decrease in the length of the belt on the slack side
 $= \alpha(T_0 - T_2)$...**(ii)**

Assuming that the belt material is perfectly elastic such that the length of the belt remains constant, when it is at rest or in motion, therefore increase in length on the tight side is equal to decrease in the length on the slack side. Thus, equating equations **(i)** and **(ii)**,

$$\alpha(T_1 - T_0) = \alpha(T_0 - T_2) \text{ or } T_1 - T_0 = T_0 - T_2$$

$$\therefore T_0 = \frac{T_1 + T_2}{2} \quad \dots(\text{Neglecting centrifugal tension})$$

$$= \frac{T_1 + T_2 + 2T_c}{2} \quad \dots(\text{Considering centrifugal tension})$$

V-belt drive

V-belt is mostly used in factories and workshops where a great amount of power is to be transmitted from one pulley to another when the two pulleys are very near to each other

The V-belts are made of fabric and cords moulded in rubber and covered with fabric and

rubber, These belts are moulded to a trapezoidal shape and are made endless. These are particularly suitable for short drives *i.e.* when the shafts are at a short distance apart. The included angle for the V-belt is usually from 30° – 40°. In case of flat belt drive, the belt runs over the pulleys whereas in case of V-belt drive, the rim of the pulley is grooved in which the V-belt runs. The effect of the groove is to increase the frictional grip of the V-belt on the pulley and thus to reduce the tendency of slipping. In order to have a good grip on the pulley, the V-belt is in contact with the side faces of the groove and not at the bottom. The power is transmitted by the *wedging action between the belt and the V-groove in the pulley

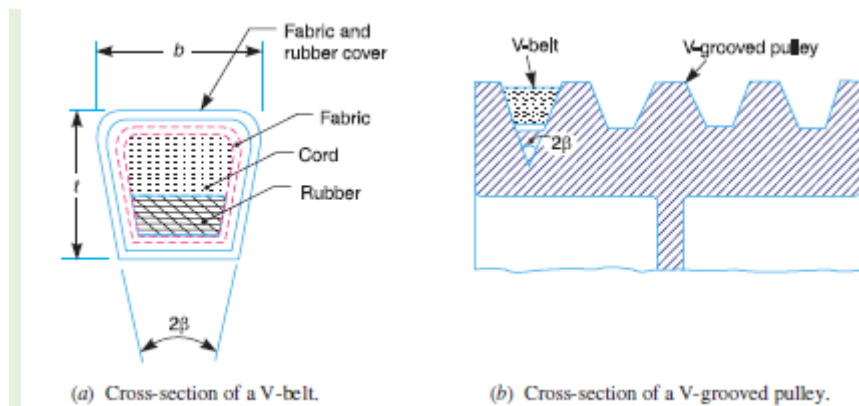

Gears

Gears are also used for power transmission. This is accomplished by the successive engagement of teeth. The two gears transmit motion by the direct contact like chain drive. Gears also provide positive drive.

The drive between the two gears can be represented by using plain cylinders or discs 1 and 2 having diameters equal to their pitch circles as shown in Figure 3.5. The point of contact of the two pitch surfaces shall have velocity along the common tangent. Because there is no slip, definite motion of gear 1 can be transmitted to gear 2 or vice-versa.

$$\text{The tangential velocity 'Vp' = } \omega_1 r_1 = \omega_2 r_2$$

where r_1 and r_2 are pitch circle radii of gears 1 and 2, respectively

Gear

Gears are also used for power transmission. This is accomplished by the successive engagement of teeth. They can be applied between two shafts which are

Parallel

Collinear

Perpendicular and intersecting

Perpendicular and nonintersecting

Inclined at any arbitrary angle

Classify gears

1. According to the position of axes of the shafts. The axes of the two shafts between which the motion is to be transmitted, may be

Parallel, (b) Intersecting, and (c) Non-intersecting and non-parallel.

2. According to the peripheral velocity of the gears. The gears, according to the peripheral

velocity of the gears may be classified as :

(a) Low velocity, (b) Medium velocity, and (c) High velocity

According to the type of gearing. The gears, according to the type of gearing may be classified as :

External gearing, (b) Internal gearing, and (c) Rack and pinion.

According to position of teeth on the gear surface. The teeth on the gear surface may be (a) straight, (b) inclined, and (c) curved

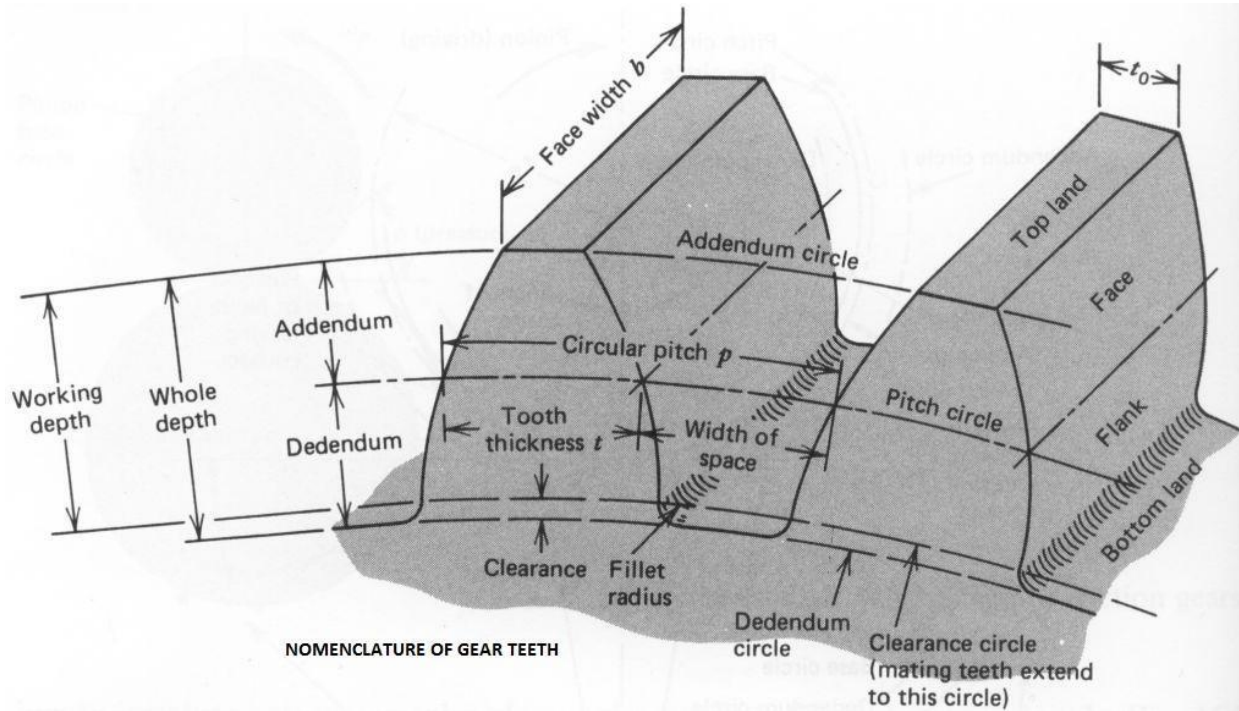

Pitch circle. It is an imaginary circle which by pure rolling action, would give the same motion as the actual gear.

2. Pitch circle diameter. It is the diameter of the pitch circle. The size of the gear is usually specified by the pitch circle diameter. It is also known as **pitch diameter**.

3. Pitch point. It is a common point of contact between two pitch circles.

4. Pitch surface. It is the surface of the rolling discs which the meshing gears have replaced at the pitch circle.

5. Pressure angle or angle of obliquity. It is the angle between the common normal to two gear teeth at the point of contact and the common tangent at the pitch point. The standard pressure angles are $14\frac{1}{2}^\circ$ and 20° .

6. Addendum. It is the radial distance of a tooth from the pitch circle to the top of the tooth.

7. Dedendum. It is the radial distance of a tooth from the pitch circle to the bottom of the tooth.

8. Addendum circle. It is the circle drawn through the top of the teeth and is concentric with the pitch circle.

9. Dedendum circle. It is the circle drawn through the bottom of the teeth. It is also called root circle.

10. Circular pitch.

It is the distance measured on the circumference of the pitch

circle from a point of one tooth to the corresponding point on the next tooth. It is usually denoted by pc .

Mathematically,

$$\text{Circular pitch, } = \pi D/T$$

Where,

D =diameter of pitch circle

T =number of teeth on the wheel

Diametral pitch. It is the ratio of number of teeth to the pitch circle diameter in millimetres.

It is denoted by pd

. Mathematically,

Diametral pitch, $P_d = T/D$

,

D =diameter of pitch circle

T =number of teeth on the wheel

Module. It is the ratio of the pitch circle diameter in millimeters to the number of teeth.

It is usually denoted by m . Mathematically,

$$m = D/T$$

Working depth. It is the radial distance from the addendum circle to the clearance circle. It is equal to the sum of the addendum of the two meshing gears.

16. Tooth thickness. It is the width of the tooth measured along the pitch circle.

17. Tooth space . It is the width of space between the two adjacent teeth measured along the pitch circle.

18. Backlash. It is the difference between the tooth space and the tooth thickness, as measured along the pitch circle. Theoretically, the backlash should be zero, but in actual practice some backlash must be allowed to prevent jamming of the teeth due to tooth errors and thermal expansion.

19. Face of tooth. It is the surface of the gear tooth above the pitch surface.

20. Flank of tooth. It is the surface of the gear tooth below the pitch surface.

21. Top land. It is the surface of the top of the tooth.

22. Face width. It is the width of the gear tooth measured parallel to its axis.

23. Profile. It is the curve formed by the face and flank of the tooth.

24. Fillet radius. It is the radius that connects the root circle to the profile of the tooth.

25. Path of contact. It is the path traced by the point of contact of two teeth from the beginning to the end of engagement.

26. *Length of the path of contact. It is the length of the common normal cut-off by the addendum circles of the wheel and pinion.

27. ** Arc of contact. It is the path traced by a point on the pitch circle from the beginning to the end of engagement of a given pair of teeth. The arc of contact consists of two parts, *i.e.*

(a) Arc of approach. It is the portion of the path of contact from the beginning of the engagement to the pitch point

Simple gear train

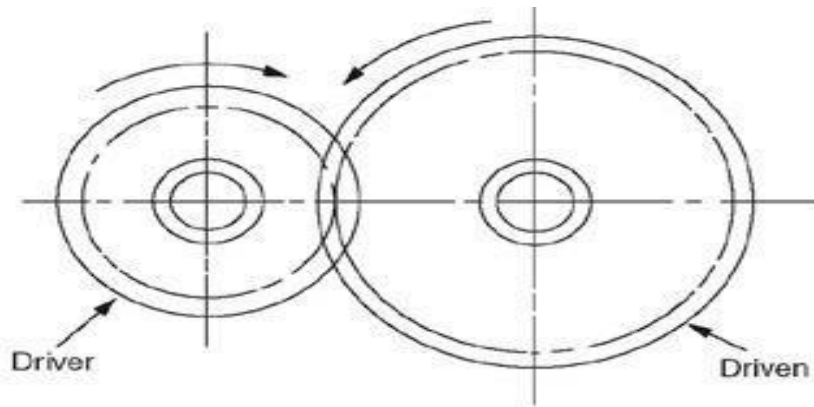

A simple gear train uses two gears, which may be of different sizes. If one of these gears is attached to a motor or a crank then it is called the driver gear. The gear that is turned by the driver gear is called the driven gear. The input and the output shaft are necessarily being parallel to each other. In this gear train, there are series of gears which are capable of receiving and transmitting motion from one gear to another. They may mesh externally or internally. Each gear rotates about separate axis fixed to the frame. Two gears may be external meshing and internal meshing.

Velocity ratio:

$$N_1/N_2=T_2/T_1=d_2/d_1$$

Compound gear train

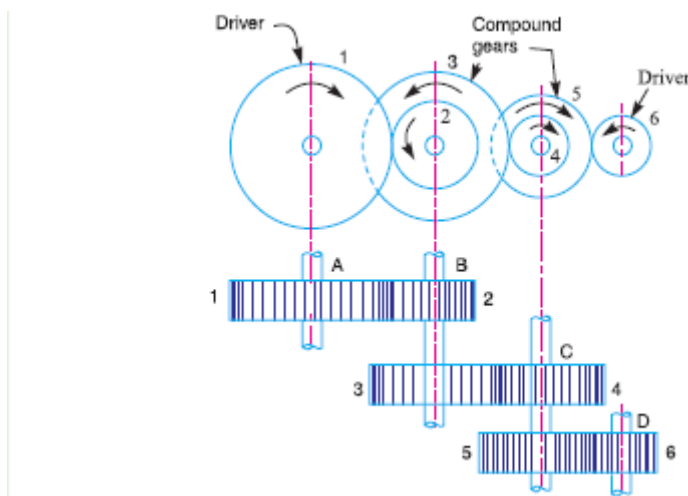

When there are more than one gear on a shaft, it is called a **compound train of gear**. in a simple train of gears do not effect the speed ratio of the system. But these gears are useful in bridging over the space between the driver and the driven

In a compound train of gears, as shown in Fig .the gear 1 is the driving gear mounted on shaft A, gears 2 and 3 are compound gears which are mounted on shaft B. The gears 4 and 5 are also compound gears which are mounted on shaft C and the gear 6 is the driven gear mounted on shaft D.

Let N_1 = Speed of driving gear 1,
 T_1 = Number of teeth on driving gear 1,
 N_2, N_3, \dots, N_6 = Speed of respective gears in r.p.m., and
 T_2, T_3, \dots, T_6 = Number of teeth on respective gears.
 Since gear 1 is in mesh with gear 2, therefore its speed ratio is

$$\frac{N_1}{N_2} = \frac{T_2}{T_1} \quad \dots(i)$$

Similarly, for gears 3 and 4, speed ratio is

$$\frac{N_3}{N_4} = \frac{T_4}{T_3} \quad \dots(ii)$$

and for gears 5 and 6, speed ratio is

$$\frac{N_5}{N_6} = \frac{T_6}{T_5} \quad \dots(iii)$$

The speed ratio of compound gear train is obtained by multiplying the equations (i), (ii) and (iii),

$$\therefore \frac{N_1}{N_2} \times \frac{N_3}{N_4} \times \frac{N_5}{N_6} = \frac{T_2}{T_1} \times \frac{T_4}{T_3} \times \frac{T_6}{T_5} \quad \text{or} \quad \frac{N_1}{N_6} = \frac{T_2 \times T_4 \times T_6}{T_1 \times T_3 \times T_5}$$

Reverted gear train

When the axes of the first gear (i.e. first driver) and the last gear (i.e. last driven or follower) are co-axial, then the gear train is known as **reverted gear train** as shown in Fig. We see that gear 1 (i.e. first driver) drives the gear 2 (i.e. first driven or follower) in the opposite direction. Since the gears 2 and 3 are mounted on the same shaft, therefore they form a compound gear and the gear 3 will rotate in the same direction as that of gear 2. The gear 3 (which is now the second driver) drives the gear 4 (i.e. the last driven or follower) in the same direction as that of gear 1. Thus we see that in a reverted gear train, the motion of the first gear and the last gear is **like**.

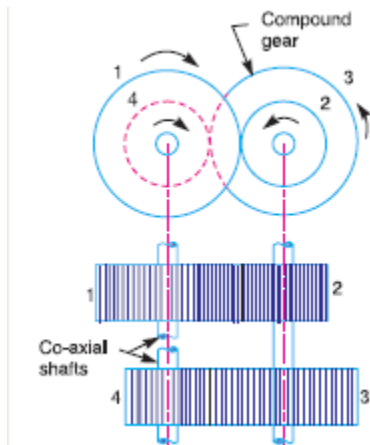

$$\text{Speed ratio} = \frac{\text{Product of number of teeth on drivers}}{\text{Product of number of teeth on driven}}$$

$$\frac{N_1}{N_4} = \frac{T_2 \times T_4}{T_1 \times T_3}$$

Epicyclic gear train

in an epicyclic gear train, the axes of the shafts, over which the gears are mounted, may move relative to a fixed axis. A simple epicyclic gear train is shown in Fig., where a gear A and the

arm C have a common axis at O_1 about which they can rotate. The gear B meshes with gear A and has its axis on the arm at O_2 , about which the gear B can rotate. If the arm is fixed, the gear train is simple and gear A can drive gear B

or **vice-versa**, but if gear A is fixed and the arm is rotated about the axis of gear A (i.e. O_1), then the gear B is forced to rotate **upon** and **around** gear A . Such a motion is called **epicyclic** and the gear trains arranged in such a manner that one or more of their members move upon and around another member are known as **epicyclic gear trains** (**epi.** means upon and **cyclic** means around). The epicyclic gear trains may be **simple** or **compound**. The epicyclic gear trains are useful for transmitting high velocity ratios with gears of moderate size in a comparatively lesser space. The epicyclic gear trains are used in the back gear of lathe, differential gears of the automobiles, hoists, pulley blocks, wrist watches etc.

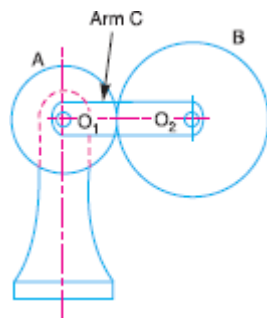

Module -4

Governors and Flywheel 4.1 Function of governor 4.2 Classification of governor 4.3 Working of Watt, Porter, Proel and Hartnell governors. 4.4 Conceptual explanation of sensitivity, stability and isochronisms. 4.5 Function of flywheel. 4.6 Comparison between flywheel & governor. 4.7 Fluctuation of energy and coefficient of fluctuation of speed.

GOVERNOR AND FLYWHEEL

Introduction

The governor is a device which is regulate the mean speed of an engine, when there are variations in the load, during long periods. On the other hand, when the load on the engine decreases, its speed increases and thus less working fluid is required.the governor has no influence over cyclic speed fluctuation.

Types of governor

Governors are classified based upon two different principles. These are:Centrifugal governors are further classified as –

- Centrifugal governor
- Inertia governors

Centrifugal governors are further classified as –

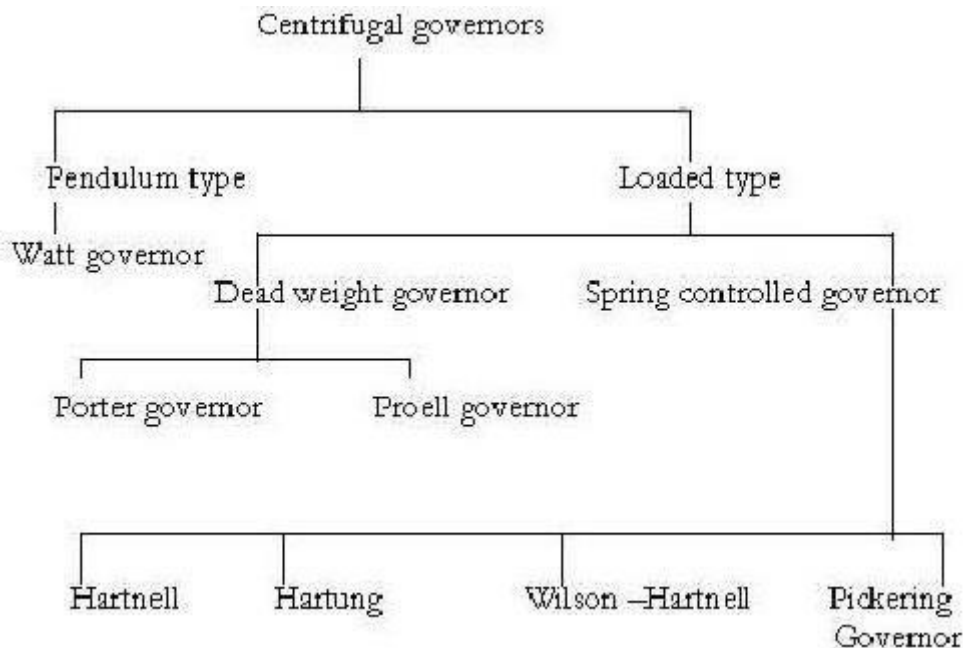

Watt Governor

The simplest form of a centrifugal governor is a Watt governor, It consist of pair of two balls and which is attached with the spindle with help of arms. The upper arm pinned at point O. the lower arm are fixed connect to the sleeve. The sleeve freely move on the spindle which is driven by engine. The spindle rotate the balls take of position depending upon speed of spindle

The arms of the governor may be connected to the spindle in the following three ways :

1. The pivot P , may be on the spindle axis.
2. The pivot P , may be offset from the spindle axis and the arms when produced intersect at O .
3. The pivot P , may be offset, but the arms cross the axis at O .

Let

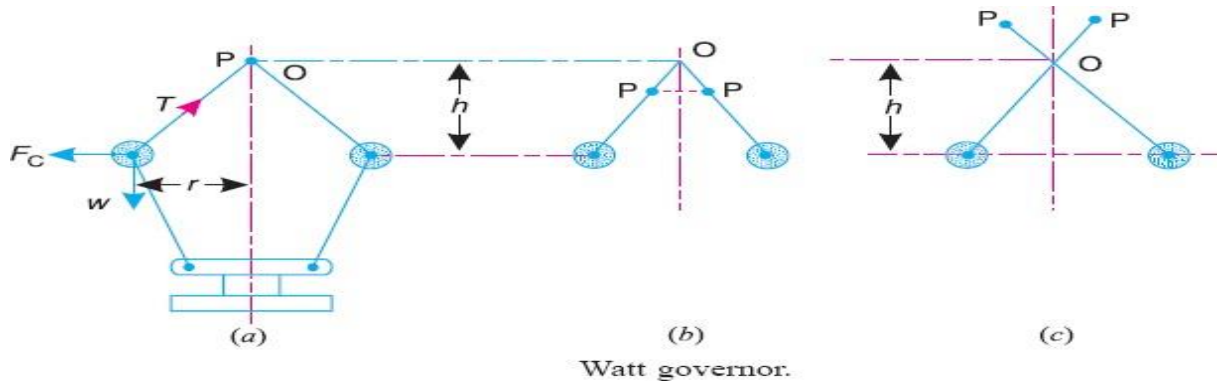

m = Mass of the ball in kg,

w = Weight of the ball in newtons = $m.g$,

T = Tension in the arm in newtons,

ω = Angular velocity of the arm and ball about the spindle axis in rad/s,

r = Radius of the path of rotation of the ball *i.e.* horizontal distance from the centre of the ball to the spindle axis in metres,

F_C = Centrifugal force acting on the ball in newtons = mv^2/r

h = Height of the governor in metres.

It is assumed that the weight of the arms, links and the sleeve are negligible as compared to the weight of the balls. Now, the ball is in equilibrium under the action of

1. the centrifugal force (F_C) acting on the ball,
2. the tension (T) in the arm,
3. the weight(w) of the ball.

Taking moments about point O , we have

$$F_C \times h = w \times r = m.g.r$$

or $m.\omega^2.r.h = m.g.r$ or $h = g / \omega^2$... (i)

When g is expressed in m/s^2 and ω in rad/s, then h is in metres. If N is the speed in r.p.m., then

$$\omega = 2\pi N/60$$

$$\therefore h = \frac{9.81}{(2\pi N/60)^2} = \frac{895}{N^2} \text{ metres} \quad \dots (\because g = 9.81 \text{ m/s}^2) \dots \text{(ii)}$$

Porter Governor

It differs from the watt governor is in the use of a heavily weighted sleeve. The load moves up and down the central spindle. This additional downward force increases the speed of revolution required to enable the balls to rise to any predetermined level.

Consider the forces acting on one-half of the governor

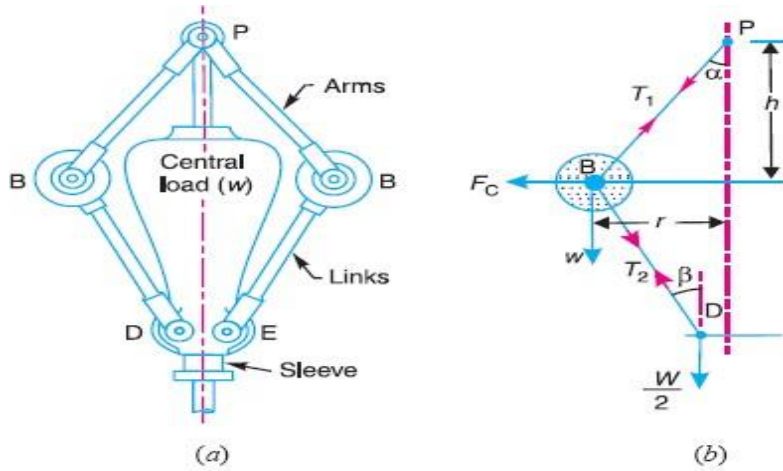

Porter governor.

- Let m = Mass of each ball in kg,
- w = Weight of each ball in newtons = $m.g$,
- M = Mass of the central load in kg,
- W = Weight of the central load in newtons = $M.g$,
- r = Radius of rotation in metres,
- h = Height of governor in metres ,
- N = Speed of the balls in r.p.m .,
- ω = Angular speed of the balls in rad/s= $2\pi N/60$ rad/s,
- F_c = Centrifugal force acting on the ball in newtons = mv^2/r ,
- T_1 = Force in the arm in newtons,
- T_2 = Force in the link in newtons,
- α = Angle of inclination of the arm (or upper link) to the vertical, and
- β = Angle of inclination of the link (or lower link) to the vertical.

The weight of arms and weight of suspension links and effect of friction to the movement of sleeve are neglected.

Though there are several ways of determining the relation between the height of the governor (h) and the angular speed of the balls (ω).

1. Method of resolution of forces

Considering the equilibrium of the forces acting at D, we have

$$T_2 \cos \beta = \frac{W}{2} = \frac{M.g}{2}$$

or

$$T_2 = \frac{M.g}{2 \cos \beta}$$

Again, considering the equilibrium of the forces acting on B . The point B is in equilibrium under the action of the following forces, as shown in Fig. 18.3 (b).

- (i) The weight of ball ($w = m.g$),
- (ii) The centrifugal force (F_C),
- (iii) The tension in the arm (T_1), and
- (iv) The tension in the link (T_2).

Resolving the forces vertically,

$$T_1 \cos \alpha = T_2 \cos \beta + w = \frac{M.g}{2} + m.g \quad \dots (ii)$$

$$\dots \left(\because T_2 \cos \beta = \frac{M.g}{2} \right)$$

Resolving the forces horizontally,

$$T_1 \sin \alpha + T_2 \sin \beta = F_C$$

$$T_1 \sin \alpha + \frac{M.g}{2 \cos \beta} \times \sin \beta = F_C \quad \dots \left(\because T_2 = \frac{M.g}{2 \cos \beta} \right)$$

$$T_1 \sin \alpha + \frac{M.g}{2} \times \tan \beta = F_C$$

$$\therefore T_1 \sin \alpha = F_C - \frac{M.g}{2} \times \tan \beta \quad \dots (iii)$$

Dividing equation (iii) by equation (ii),

$$\frac{T_1 \sin \alpha}{T_1 \cos \alpha} = \frac{F_C - \frac{M.g}{2} \times \tan \beta}{\frac{M.g}{2} + m.g}$$

or $\left(\frac{M.g}{2} + m.g \right) \tan \alpha = F_C - \frac{M.g}{2} \times \tan \beta$

$$\frac{M.g}{2} + m.g = \frac{F_C}{\tan \alpha} - \frac{M.g}{2} \times \frac{\tan \beta}{\tan \alpha}$$

Substituting $\frac{\tan \beta}{\tan \alpha} = q$, and $\tan \alpha = \frac{r}{h}$, we have

$$\frac{M.g}{2} + m.g = m.\omega^2.r \times \frac{h}{r} - \frac{M.g}{2} \times q \quad \dots (\because F_C = m.\omega^2.r)$$

or $m.\omega^2.h = m.g + \frac{M.g}{2} (1 + q)$

$$\therefore h = \left[m.g + \frac{M.g}{2} (1 + q) \right] \frac{1}{m.\omega^2} = \frac{m + \frac{M}{2} (1 + q)}{m} \times \frac{g}{\omega^2} \quad \dots (iv)$$

or $\omega^2 = \left[m.g + \frac{M.g}{2} (1 + q) \right] \frac{1}{m.h} = \frac{m + \frac{M}{2} (1 + q)}{m} \times \frac{g}{h}$

or $\left(\frac{2\pi N}{60} \right)^2 = \frac{m + \frac{M}{2} (1 + q)}{m} \times \frac{g}{h}$

$$\therefore N^2 = \frac{m + \frac{M}{2} (1 + q)}{m} \times \frac{g}{h} \left(\frac{60}{2\pi} \right)^2 = \frac{m + \frac{M}{2} (1 + q)}{m} \times \frac{895}{h}$$

2. Instantaneous centre method

In this method, equilibrium of the forces acting on the link BD are considered. The instantaneous centre I lies at the point of intersection of PB produced and a line through D perpendicular to the spindle axis, as shown in Fig. 18.4. Taking moments about the point I ,

$$\begin{aligned}
 F_C \times BM &= w \times IM + \frac{W}{2} \times ID \\
 &= m \cdot g \times IM + \frac{M \cdot g}{2} \times ID \\
 \therefore F_C &= m \cdot g \times \frac{IM}{BM} + \frac{M \cdot g}{2} \times \frac{ID}{BM} \\
 &= m \cdot g \times \frac{IM}{BM} + \frac{M \cdot g}{2} \left(\frac{IM + MD}{BM} \right) \\
 &= m \cdot g \times \frac{IM}{BM} + \frac{M \cdot g}{2} \left(\frac{IM}{BM} + \frac{MD}{BM} \right) \\
 &= m \cdot g \tan \alpha + \frac{M \cdot g}{2} (\tan \alpha + \tan \beta)
 \end{aligned}$$

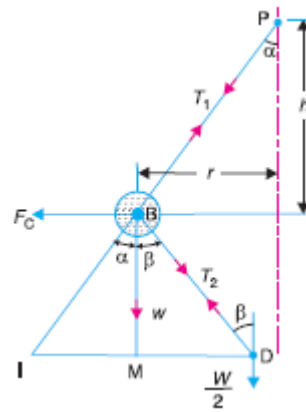

Dividing throughout by $\tan \alpha$,

$$\frac{F_C}{\tan \alpha} = m \cdot g + \frac{M \cdot g}{2} \left(1 + \frac{\tan \beta}{\tan \alpha} \right) = m \cdot g + \frac{M \cdot g}{2} (1 + q) \quad \dots \left(\because q = \frac{\tan \beta}{\tan \alpha} \right)$$

We know that $F_C = m \cdot \omega^2 r$, and $\tan \alpha = \frac{r}{h}$

$$\therefore m \cdot \omega^2 r \times \frac{h}{r} = m \cdot g + \frac{M \cdot g}{2} (1 + q)$$

or

$$h = \frac{m \cdot g + \frac{M \cdot g}{2} (1 + q)}{m} \times \frac{1}{\omega^2} = \frac{m + \frac{M}{2} (1 + q)}{m} \times \frac{g}{\omega^2}$$

When $\tan \alpha = \tan \beta$ or $q = 1$, then

$$h = \frac{m + M}{m} \times \frac{g}{\omega^2}$$

Proell Governor

The proell governor has ball fixed at B and C at extension of link DF and EG . The aem FP and GQ are pivoted at P and Q respectively

Consider the equilibrium forces one-half of governor as shown in fig b.the instantneous centr I lies on the intersection of line PF produced and from D drawn perpendicular to spindle axis. The perpendicular BM is drawn on ID

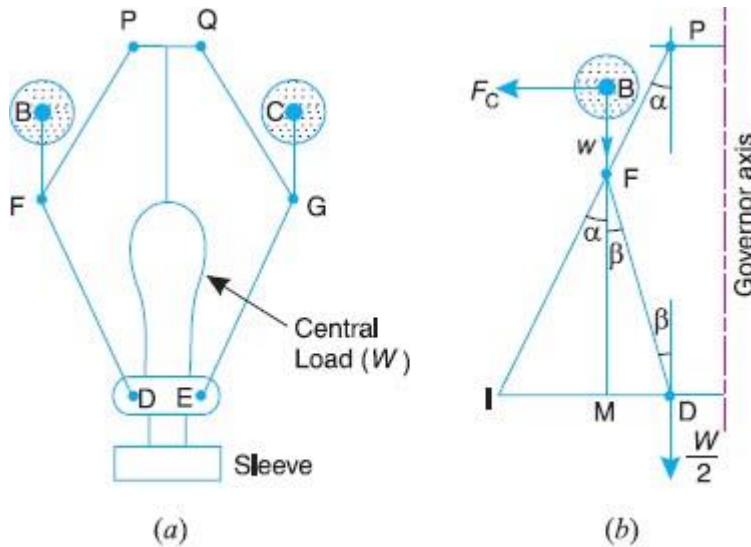

Fig. Proell governor.

Taking moments about I, using the same notations

$$F_C \times BM = w \times IM + \frac{W}{2} \times ID = m \cdot g \times IM + \frac{M \cdot g}{2} \times ID \quad \dots (i)$$

$$\therefore F_C = m \cdot g \times \frac{IM}{BM} + \frac{M \cdot g}{2} \left(\frac{IM + MD}{BM} \right) \quad \dots (\because ID = IM + MD)$$

Multiplying and dividing by FM, we have

$$\begin{aligned} F_C &= \frac{FM}{BM} \left[m \cdot g \times \frac{IM}{FM} + \frac{M \cdot g}{2} \left(\frac{IM}{FM} + \frac{MD}{FM} \right) \right] \\ &= \frac{FM}{BM} \left[m \cdot g \times \tan \alpha + \frac{M \cdot g}{2} (\tan \alpha + \tan \beta) \right] \\ &= \frac{FM}{BM} \times \tan \alpha \left[m \cdot g + \frac{M \cdot g}{2} \left(1 + \frac{\tan \beta}{\tan \alpha} \right) \right] \end{aligned}$$

We know that $F_C = m \cdot \omega^2 r$; $\tan \alpha = \frac{r}{h}$ and $q = \frac{\tan \beta}{\tan \alpha}$

$$\therefore m \cdot \omega^2 \cdot r = \frac{FM}{BM} \times \frac{r}{h} \left[m \cdot g + \frac{M \cdot g}{2} (1 + q) \right]$$

and
$$\omega^2 = \frac{FM}{BM} \left[\frac{m + \frac{M}{2} (1 + q)}{m} \right] \frac{g}{h} \quad \dots (ii)$$

Substituting $\omega = 2\pi N/60$, and $g = 9.81 \text{ m/s}^2$, we get

$$N^2 = \frac{FM}{BM} \left[\frac{m + \frac{M}{2} (1 + q)}{m} \right] \frac{895}{h} \quad \dots (iii)$$

Hartnell Governor

A Hartnell governor is a spring loaded governor. It consists of two bell crank levers pivoted at the points O, O to the frame. The frame is attached to the governor spindle and therefore rotates with it. Each lever carries a ball at the end of the vertical arm OB and a roller at the end of the horizontal arm OR. A helical spring in compression provides equal downward forces on the two rollers through a collar on the sleeve. The spring force may be adjusted by screwing a nut up or down on the sleeve.

Let m = Mass of each ball in kg,

M = Mass of sleeve in kg,

r_1 = Minimum radius of rotation in metres,

r_2 = Maximum radius of rotation in metres

ω_1 = Angular speed of the governor at minimum radius in rad/s,

ω_2 = Angular speed of the governor at maximum radius in rad/s,

S_1 = Spring force exerted on the sleeve

S_2 = Spring force exerted on the sleeve at

F_{C1} = Centrifugal force = $m (\omega_1)^2 r$

F_{C2} = Centrifugal force at = $m (\omega_2)^2 r_2$,

s = Stiffness of the spring or the force required to compress the spring by one mm,

x = Length of the vertical or ball arm of the lever in metres,

y = Length of the horizontal or sleeve arm of the lever in metres, and

r = Distance of fulcrum O from the governor axis or the radius of rotation when the governor is in mid-position.

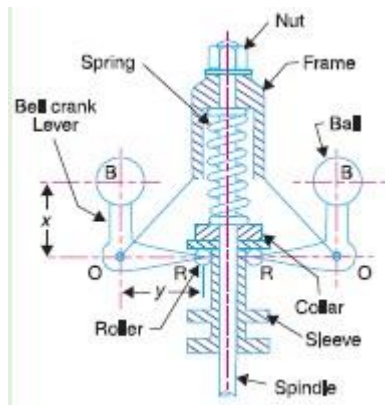

Consider the forces acting at one bell crank lever. The minimum and maximum position is shown in Fig.. Let h be the compression of the spring when the radius of rotation changes from r_1 to r_2 .

$$\frac{h_1}{y} = \frac{a_1}{x} = \frac{r - r_1}{x} \quad \dots (i)$$

$$\frac{h_2}{y} = \frac{a_2}{x} = \frac{r_2 - r}{x} \quad \dots (ii)$$

Adding equations (i) and (ii),

$$\frac{h_1 + h_2}{y} = \frac{r_2 - r_1}{x} \quad \text{or} \quad \frac{h}{y} = \frac{r_2 - r_1}{x} \quad \dots (\because h = h_1 + h_2)$$

$$\therefore h = (r_2 - r_1) \frac{y}{x} \quad \dots (iii)$$

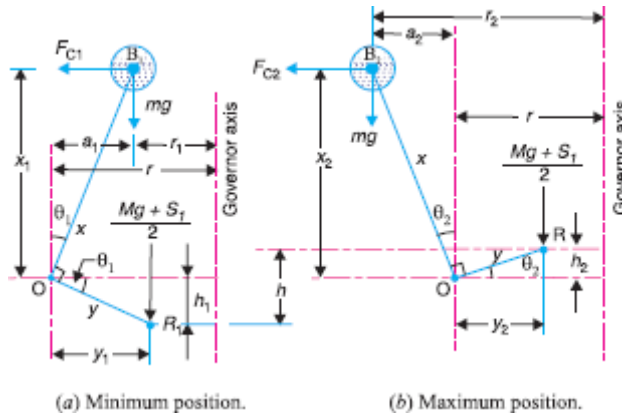

Now for minimum position, taking moments about point O, we get

$$\frac{M \cdot g + S_1}{2} \times y_1 = F_{C1} \times x_1 - m \cdot g \times a_1$$

or
$$M \cdot g + S_1 = \frac{2}{y_1} (F_{C1} \times x_1 - m \cdot g \times a_1) \quad \dots (iv)$$

Again for maximum position, taking moments about point O, we get

$$\frac{M \cdot g + S_2}{2} \times y_2 = F_{C2} \times x_2 + m \cdot g \times a_2$$

or
$$M \cdot g + S_2 = \frac{2}{y_2} (F_{C2} \times x_2 + m \cdot g \times a_2) \quad \dots (v)$$

Subtracting equation (iv) from equation (v),

$$S_2 - S_1 = \frac{2}{y_2} (F_{C2} \times x_2 + m \cdot g \times a_2) - \frac{2}{y_1} (F_{C1} \times x_1 - m \cdot g \times a_1)$$

We know that

$$S_2 - S_1 = h \cdot s, \quad \text{and} \quad h = (r_2 - r_1) \frac{y}{x}$$

$$\therefore s = \frac{S_2 - S_1}{h} = \left(\frac{S_2 - S_1}{r_2 - r_1} \right) \frac{x}{y}$$

Neglecting the obliquity effect of the arms (i.e. $x_1 = x_2 = x$, and $y_1 = y_2 = y$) and the moment due to weight of the balls (i.e. $m \cdot g$), we have for minimum position,

$$\frac{M \cdot g + S_1}{2} \times y = F_{C1} \times x \quad \text{or} \quad M \cdot g + S_1 = 2F_{C1} \times \frac{x}{y} \quad \dots (vi)$$

Similarly for maximum position,

$$\frac{M \cdot g + S_2}{2} \times y = F_{C2} \times x \quad \text{or} \quad M \cdot g + S_2 = 2F_{C2} \times \frac{x}{y} \quad \dots (vii)$$

Subtracting equation (vi) from equation (vii),

$$S_2 - S_1 = 2 (F_{C2} - F_{C1}) \frac{x}{y} \quad \dots (viii)$$

We know that

$$S_2 - S_1 = h \cdot s, \quad \text{and} \quad h = (r_2 - r_1) \frac{y}{x}$$

$$\therefore s = \frac{S_2 - S_1}{h} = 2 \left(\frac{F_{C2} - F_{C1}}{r_2 - r_1} \right) \left(\frac{x}{y} \right)^2 \quad \dots (ix)$$

Sensitiveness of Governors

A governor is said to be sensitive, if its change of speed s from no Load to full load may

be as small a fraction of the mean equilibrium speed as possible and the corresponding sleeve lift may be as large as possible.

Suppose $\omega_1 = \text{max. Equilibrium speed}$

$\omega_2 = \text{min. equilibrium speed}$

$\omega = \text{mean equilibrium speed} = (\omega_1 + \omega_2)/2$

Therefore sensitiveness = $(\omega_1 - \omega_2)/2$

Stability of Governors

A governor is said to be *stable* when for every speed within the working range there is definite configuration *i.e.* there is only one radius of rotation of the governor balls at which the governor equilibrium. For a stable governor, if the equilibrium speed increases, the radius of governor balls must also increase.

Isochronous Governors

This is an extreme case of sensitiveness. When the equilibrium speed is constant for all radii of rotation of the balls within the working range, the governor is said to be in isochronism. This means that the difference between the maximum and minimum equilibrium speeds is zero and the sensitiveness shall be infinite.

FLYWHEEL:-

A flywheel is a wheel of heavy mass mounted on the crank shaft and it stores energy during the period when the supply of energy is more

during the period when the fly wheel absorbs energy its speed increases and during the period when it releases energy its speed decreases.

In engine, the flywheel absorbs the stroke and gives out the energy during idle strokes and thus keeps the maximum speed and minimum speed of crankshaft near the mean shaft in a thermodynamic cycle.

In power press, the flywheel absorbs the mechanical energy produced by electric motor during idle period and gives the energy when actual operation is performed. In this way with the use of flywheel, motor of smaller capacity is able to serve the purpose.

Fluctuation of Energy

The fluctuation of energy may be determined by the turning moment diagram for one complete cycle of operation. Consider the turning moment diagram for a single cylinder double acting steam engine as shown in Fig.

We see that the mean resisting torque line AF cuts the turning moment diagram at points B, C, D and E . When the crank moves from a to p , the work done by the engine is equal to the area aBp , whereas the energy required is represented by the area $aABp$. In other words, the engine has done less work (equal to the area aAB) than the requirement. This amount of energy is taken from the flywheel and hence the speed of the flywheel decreases. Now the crank moves from p to q , the work done by the engine is equal to the area $pBbCq$, whereas the requirement of energy is represented by the area $pBCq$. Therefore, the engine has done more work than the requirement.

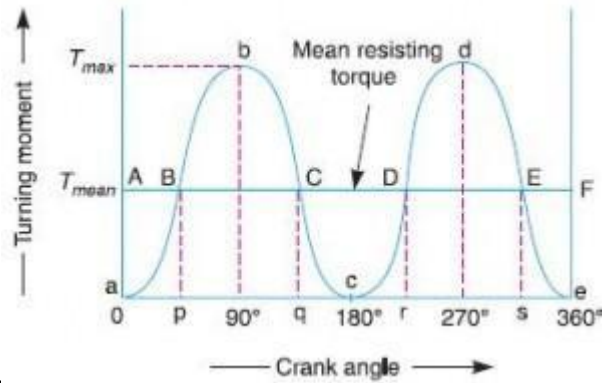

This excess work (equal to the area BbC) is stored in the flywheel and hence the speed of the flywheel increases while the crank moves from p to q . Similarly, when the crank moves from q to r , more work is taken from the engine than is developed. This loss of work is represented by the area CcD . To supply this loss, the flywheel gives up some of its energy and thus the speed decreases while the crank moves from q to r . As the crank moves from r to s , excess energy is again developed given by the area DdE and the speed again increases. As the piston moves from s to e , again there is a loss of work and the speed decreases. The variations of energy above and below the mean resisting torque line are called *fluctuations of energy*.

Maximum fluctuation of energy

Determination of Maximum Fluctuation of Energy

A turning moment diagram for a multi-cylinder engine is shown by a wavy curve in Fig.

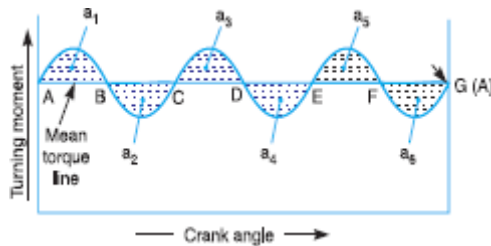

The horizontal line AG represents the mean torque line. Let a_1, a_3, a_5 be the areas above the mean torque line and a_2, a_4 and a_6 be the areas below the mean torque line. These areas represent some quantity of energy which is either added or subtracted from the energy of the moving parts of the engine.

Let the energy in the flywheel at $A = E$,

then from Fig. 16.4, we have

Energy at $B = E + a_1$

Energy at $C = E + a_1 - a_2$

Energy at $D = E + a_1 - a_2 + a_3$

Energy at $E = E + a_1 - a_2 + a_3 - a_4$

Energy at $F = E + a_1 - a_2 + a_3 - a_4 + a_5$

Energy at $G = E + a_1 - a_2 + a_3 - a_4 + a_5 - a_6 = \text{Energy at } A \text{ (i.e. cycle repeats after } G)$

Let us now suppose that the greatest of these energies is at B and least at E . Therefore,

Maximum energy in flywheel = $E + a_1$

Minimum energy in the flywheel = $E + a_1 - a_2 + a_3 - a_4$

$\Delta E = \text{Maximum fluctuation of energy,}$
 $\Delta E = \text{Maximum energy} - \text{Minimum energy}$
 $= (E + a_1) - (E + a_1 - a_2 + a_3 - a_4) = a_2 - a_3 + a_4$

Coefficient of Fluctuation of Energy

It may be defined as the **ratio of the maximum fluctuation of energy to the work done per cycle.** Mathematically, coefficient of fluctuation of energy

$C_E = \text{Maximum fluctuation of energy} / \text{Work done per cycle}$

$$C_E = \frac{\text{Maximum fluctuation of energy}}{\text{Work done per cycle}}$$

Fluctuation of speed

When flywheel absorbs energy its speed rises and when it gives up energy its speed decreases. The difference between maximum speed and minimum speed is called as fluctuation of speed.

Coefficient of Fluctuation of speed

The ratio of fluctuation of speed to the mean speed is called Coefficient of Fluctuation of speed

It is denoted as K_s .

$\omega_1 = \text{maximum angular velocity of flywheel at maximum speed in r.p.m } N_1$

$\omega_2 = \text{minimum angular velocity of flywheel at minimum speed in r.p.m } N_2$

$\omega = \text{mean angular velocity of flywheel at mean speed in r.p.m } N$

According to the theory,

$$K_s = (\omega_1 - \omega_2) / \omega$$

Energy Stored in a Flywheel

A flywheel is shown in Fig. that when a flywheel absorbs energy, its speed increases and when it gives up energy, its speed decreases.

Let $m = \text{Mass of the flywheel in kg,}$

$k = \text{Radius of gyration of the flywheel in metres}$

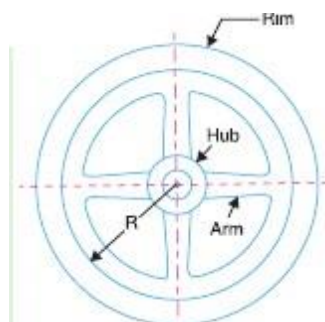

I = Mass moment of inertia of the flywheel about its axis of rotation in $\text{kg}\cdot\text{m}^2 = m\cdot k^2$,

N_1 and N_2 = Maximum and minimum speeds during the cycle in r.p.m.,

ω_1 and ω_2 = Maximum and minimum angular speeds during the cycle in rad/s,

$$N = \text{Mean speed during the cycle in r.p.m.} = \frac{N_1 + N_2}{2},$$

$$\omega = \text{Mean angular speed during the cycle in rad/s} = \frac{\omega_1 + \omega_2}{2},$$

$$C_S = \text{Coefficient of fluctuation of speed} = \frac{N_1 - N_2}{N} \text{ or } \frac{\omega_1 - \omega_2}{\omega}$$

We know that the mean kinetic energy of the flywheel,

$$E = \frac{1}{2} \times I \cdot \omega^2 = \frac{1}{2} \times m \cdot k^2 \cdot \omega^2 \quad (\text{in N-m or joules})$$

As the speed of the flywheel changes from ω_1 to ω_2 , the maximum fluctuation of energy,

$\Delta E = \text{Maximum K.E.} - \text{Minimum K.E.}$

$$= \frac{1}{2} \times I (\omega_1)^2 - \frac{1}{2} \times I (\omega_2)^2 = \frac{1}{2} \times I \left[(\omega_1)^2 - (\omega_2)^2 \right]$$

$$= \frac{1}{2} \times I (\omega_1 + \omega_2)(\omega_1 - \omega_2) = I \cdot \omega (\omega_1 - \omega_2) \quad \dots(i)$$

$$\dots \left(\because \omega = \frac{\omega_1 + \omega_2}{2} \right)$$

$$= I \cdot \omega^2 \left(\frac{\omega_1 - \omega_2}{\omega} \right) \quad \dots (\text{Multiplying and dividing by } \omega)$$

$$= I \cdot \omega^2 \cdot C_S = m \cdot k^2 \cdot \omega^2 \cdot C_S \quad \dots (\because I = m \cdot k^2) \quad \dots(ii)$$

$$= 2 \cdot E \cdot C_S \quad (\text{in N-m or joules}) \quad \dots \left(\because E = \frac{1}{2} \times I \cdot \omega^2 \right) \quad \dots(iii)$$

Module-5

Explain the concept of balancing:

Explain static balancing of rotating parts:

Explain the principle of balancing of reciprocating masses:

State the causes and effect of unbalance:

Different between static and dynamic balancing.:

Explain the concept of balancing:

Balancing is the process of eliminating or at least reducing the ground forces and/or moments. It is achieved by changing the location of the mass centres of links. Balancing of rotating parts is a well known problem. A rotating body with fixed rotation axis can be fully balanced i.e. all the inertia forces and moments. For mechanism containing links rotating about axis which are not fixed, force balancing is possible, moment balancing by itself may be possible, but both not possible. We generally try to do force balancing. A fully force balance is possible, but any action in force balancing severe the moment balancing

Balancing of rotating masses: The process of providing the second mass in order to counteract the effect of the centrifugal force of the first mass is called balancing of rotating masses.

Static balancing: The net dynamic force acting on the shaft is equal to zero. This requires that the line of action of three centrifugal forces must be the same. In other words, the centre of the masses of the system must lie on the axis of the rotation. This is the condition for static balancing.

Dynamic balancing: The net couple due to dynamic forces acting on the shaft is equal to zero. The algebraic sum of the moments about any point in the plane must be zero.

Static balancing of rotating mass

Balancing of a single rotating mass by single mass rotating in the same plane:

Consider a disturbing mass m_1 attached to a shaft rotating at ω rad/s as shown in Fig. Let r_1 be the radius of rotation of the mass m_1 (i.e. distance between the axis of rotation of the shaft and the centre of gravity of the mass m_1).

We know that the centrifugal force exerted by the mass m_1 on the shaft,

$$F_{C1} = m_1 \cdot \omega^2 \cdot r_1 \quad \dots (i)$$

This centrifugal force acts radially outwards and thus produces bending moment on the shaft. In order to counteract the effect of this force, a balancing mass (m_2) may be attached in the same plane of rotation as that of disturbing mass (m_1) such that the centrifugal forces due to the two masses are equal and opposite.

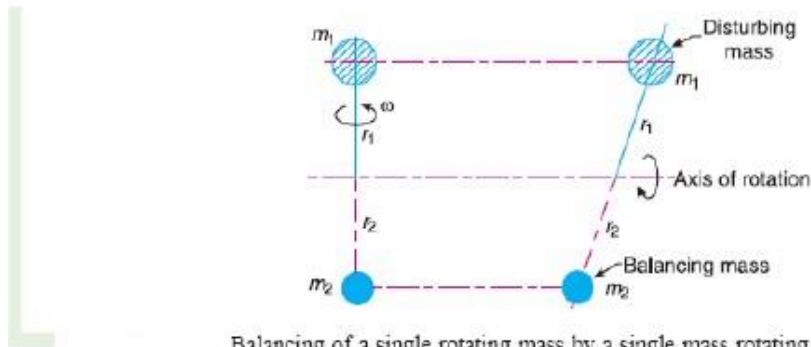

Balancing of a single rotating mass by a single mass rotating in the same plane.

Let r_2 = Radius of rotation of the balancing mass m_2 (i.e. distance between the axis of rotation of the shaft and the centre of gravity of mass m_2).

∴ Centrifugal force due to mass m_2 ,

$$F_{C2} = m_2 \cdot \omega^2 \cdot r_2 \quad \dots (ii)$$

Equating equations (i) and (ii),

$$m_1 \omega^2 \cdot r_1 = m_2 \cdot \omega^2 \cdot r_2 \quad \text{or} \quad m_1 \cdot r_1 = m_2 \cdot r_2$$

CASE 2:

BALANCING OF A SINGLE ROTATING MASS BY TWO MASSES ROTATING IN DIFFERENT PLANES.

There are two possibilities while attaching two balancing masses:

1. The plane of the disturbing mass may be in between the planes of the two balancing masses.
2. The plane of the disturbing mass may be on the left or right side of two planes containing the balancing masses.

In order to balance a single rotating mass by two masses rotating in different planes

which are parallel to the plane of rotation of the disturbing mass i) the net dynamic force acting on the shaft must be equal to zero, i.e. the centre of the masses of the system must lie on the axis of rotation and this is the condition for static balancing ii) the net couple due to the dynamic forces acting on the shaft must be equal to zero, i.e. the algebraic sum of the moments about any point in the plane must be zero. The conditions i) and ii) together give dynamic balancing.

THE PLANE OF THE DISTURBING MASS LIES IN BETWEEN THE PLANES OF THE TWO BALANCING MASSES.

The plane of the disturbing mass lies inbetween the planes of the two balancing masses

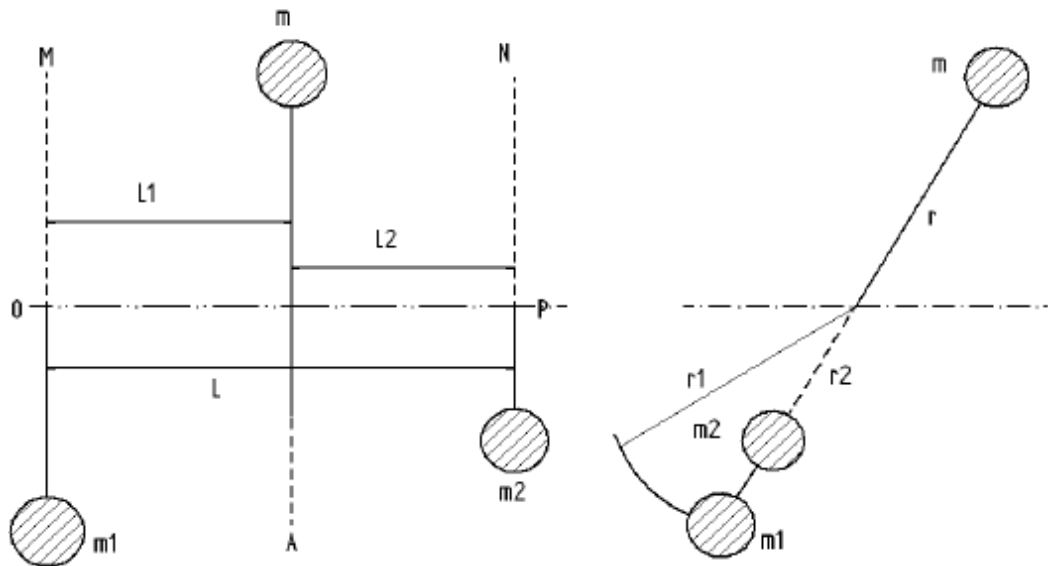

Consider the disturbing mass m lying in a plane A which is to be balanced by two rotating masses m_1 and m_2 lying in two different planes M and N which are parallel to the plane A as shown.

Let r , r_1 and r_2 be the radii of rotation of the masses in planes A , M and N respectively. Let L_1 , L_2 and L be the distance between A and M , A and N , and M and N respectively. Now,

The centrifugal force exerted by the mass m in plane A will be,

$$F_c = m \omega^2 r \text{-----(1)}$$

Similarly,

The centrifugal force exerted by the mass m_1 in plane M will be,

$$F_{c1} = m_1 \omega^2 r_1 \text{-----(2)}$$

And the centrifugal force exerted by the mass m_2 in plane N will be,

$$F_{c2} = m_2 \omega^2 r_2 \text{-----(3)}$$

For the condition of static balancing,

$$\begin{aligned} F_c &= F_{c1} + F_{c2} \\ \text{or } m \omega^2 r &= m_1 \omega^2 r_1 + m_2 \omega^2 r_2 \\ \text{i.e. } m r &= m_1 r_1 + m_2 r_2 \text{-----(4)} \end{aligned}$$

Now, to determine the magnitude of balancing force in the plane 'M' or the dynamic force at the bearing 'O' of a shaft, take moments about 'P' which is the point of intersection of the plane N and the axis of rotation.

Therefore,

$$\begin{aligned} F_{c1} \times L &= F_c \times L_2 \\ \text{or } m_1 \omega^2 r_1 \times L &= m \omega^2 r \times L_2 \\ \text{Therefore,} \\ m_1 r_1 L &= m r L_2 \text{ or } m_1 r_1 = m r \frac{L_2}{L} \text{-----(5)} \end{aligned}$$

Similarly, in order to find the balancing force in plane 'N' or the dynamic force at the bearing 'P' of a shaft, take moments about 'O' which is the point of intersection of the plane M and the axis of rotation.

Therefore,

$$\begin{aligned} F_{c2} \times L &= F_c \times L_1 \\ \text{or } m_2 \omega^2 r_2 \times L &= m \omega^2 r \times L_1 \\ \text{Therefore,} \\ m_2 r_2 L &= m r L_1 \text{ or } m_2 r_2 = m r \frac{L_1}{L} \text{-----(6)} \end{aligned}$$

For dynamic balancing equations (5) or (6) must be satisfied along with equation (4).

CASE 2(II):

WHEN THE PLANE OF THE DISTURBING MASS LIES ON ONE END OF THE TWO PLANES CONTAINING THE BALANCING MASSES.

When the plane of the disturbing mass lies on one end of the planes of the balancing masses

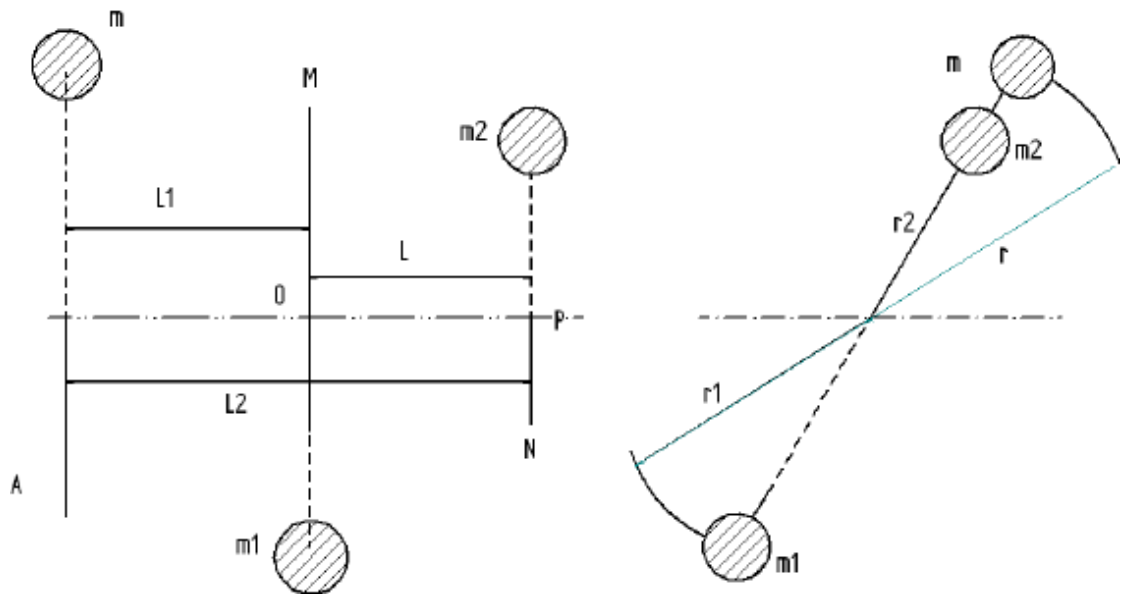

For static balancing,

$$F_{c1} = F_c + F_{c2}$$

$$\text{or } m_1 \omega^2 r_1 = m \omega^2 r + m_2 \omega^2 r_2$$

$$\text{i.e. } m_1 r_1 = m r + m_2 r_2 \text{-----(1)}$$

For dynamic balance the net dynamic force acting on the shaft and the net couple due to dynamic forces acting on the shaft is equal to zero.

To find the balancing force in the plane 'M' or the dynamic force at the bearing 'O' of a shaft, take moments about 'P'. i.e.

$$F_{c1} \times L = F_c \times L_2$$

$$\text{or } m_1 \omega^2 r_1 \times L = m \omega^2 r \times L_2$$

Therefore,

$$m_1 r_1 L = m r L_2 \text{ or } m_1 r_1 = m r \frac{L_2}{L} \text{-----(2)}$$

Similarly, to find the balancing force in the plane 'N', take moments about 'O', i.e.,

$$F_{c2} \times L = F_c \times L_1$$

$$\text{or } m_2 \omega^2 r_2 \times L = m \omega^2 r \times L_1$$

Therefore,

$$m_2 r_2 L = m r L_1 \text{ or } m_2 r_2 = m r \frac{L_1}{L} \text{-----(3)}$$

**CASE 3:
BALANCING OF SEVERAL MASSES ROTATING IN THE SAME PLANE**

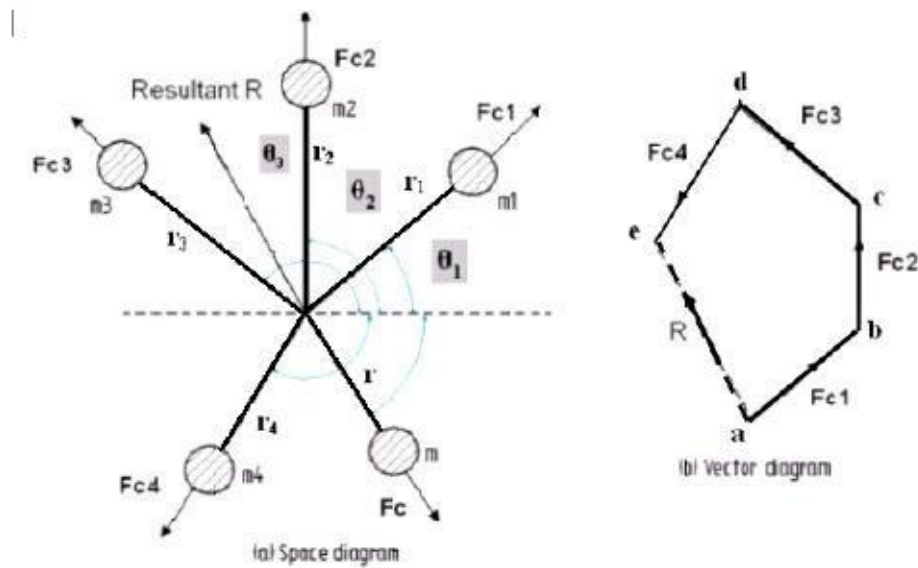

BALANCING OF SEVERAL MASSES ROTATING IN THE SAME PLANE

Consider a rigid rotor revolving with a constant angular velocity ω rad/s. A number of masses say, four are depicted by point masses at different radii in the same transverse plane

If m_1, m_2, m_3 and m_4 are the masses revolving at radii r_1, r_2, r_3 and r_4 respectively in the same plane.

The centrifugal forces exerted by each of the masses are F_{c1}, F_{c2}, F_{c3} and F_{c4} respectively. Let F be the vector sum of these forces. i.e.

$$F = F_{c1} + F_{c2} + F_{c3} + F_{c4}$$

$$= m_1 \omega^2 r_1 + m_2 \omega^2 r_2 + m_3 \omega^2 r_3 + m_4 \omega^2 r_4 \text{----- (1)}$$

The rotor is said to be statically balanced if the vector sum F is zero. If the vector sum F is not zero, i.e. the rotor is unbalanced, then introduce a counterweight (balance weight) of mass ' m ' at radius ' r ' to balance the rotor so that,

$$m_1 \omega^2 r_1 + m_2 \omega^2 r_2 + m_3 \omega^2 r_3 + m_4 \omega^2 r_4 + m \omega^2 r = 0 \text{----- (2)}$$

or

$$m_1 r_1 + m_2 r_2 + m_3 r_3 + m_4 r_4 + m r = 0 \text{----- (3)}$$

The magnitude of either ' m ' or ' r ' may be selected and the other can be calculated. In general, if $\sum m_i r_i$ is the vector sum of $m_1 r_1, m_2 r_2, m_3 r_3, m_4 r_4$ etc, then,

$$\sum m_i r_i + m r = 0 \text{----- (4)}$$

CASE 4:

BALANCING OF SEVERAL MASSES ROTATING IN DIFFERENT PLANES

When several masses revolve in different planes, they may be transferred to a reference plane and this reference plane is a plane passing through a point on the axis of rotation and perpendicular to it.

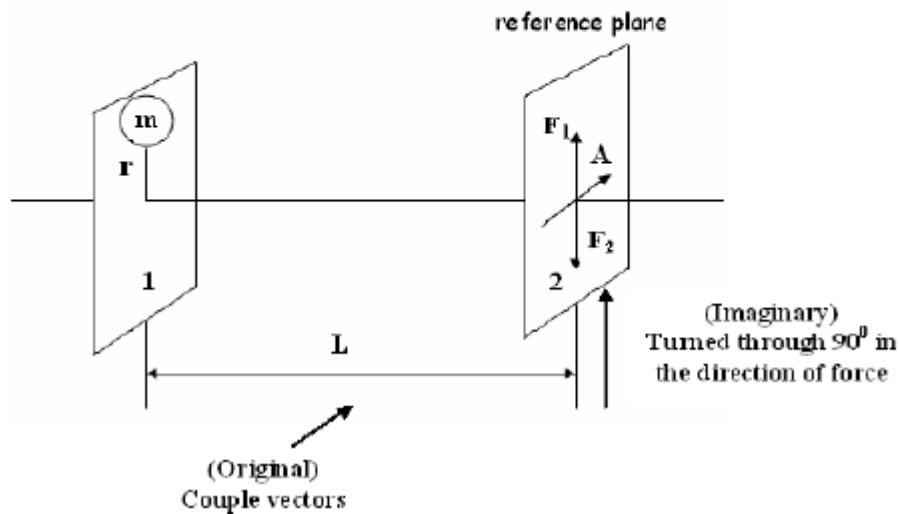

When a revolving mass in one plane is transferred to a reference plane, its effect is to cause a force of same magnitude to the centrifugal force of the revolving mass to act in the reference plane along with a couple of magnitude equal to the product of the force and the distance between the two planes.

In order to have a complete balance of the several revolving masses in different planes,

1. the forces in the reference plane must balance, i.e., the resultant force must be zero and
2. the couples about the reference plane must balance i.e., the resultant couple must be zero.

A mass placed in the reference plane may satisfy the first condition but the couple balance is satisfied only by two forces of equal magnitude in different planes. Thus, in general, two planes are needed to balance a system of rotating masses

balancing of reciprocating engine

Slider Crank Mechanism:

Primary And Secondary Accelerating Force

Acceleration of the reciprocating mass of a slider-crank mechanism is given by,

$$a_p = \text{Acceleration of piston}$$

$$= r \omega^2 \left[\cos\theta + \frac{\cos 2\theta}{n} \right] \text{----- (1)}$$

$$\text{Where } n = \frac{l}{r}$$

And, the force required to accelerate the mass 'm' is

$$F_i = m r \omega^2 \left[\cos\theta + \frac{\cos 2\theta}{n} \right]$$

$$= m r \omega^2 \cos\theta + m r \omega^2 \frac{\cos 2\theta}{n} \text{----- (2)}$$

The first term of the equation (2) , i.e. $m r \omega^2 \cos\theta$ is called **primary accelerating force** the second term $m r \omega^2 \frac{\cos 2\theta}{n}$ is called the **secondary accelerating force**.

Maximum value of primary accelerating force is $m r \omega^2$

And Maximum value of secondary accelerating force is $\frac{m r \omega^2}{n}$

Generally, 'n' value is much greater than one; the secondary force is small compared to primary force and can be safely neglected for slow speed engines.

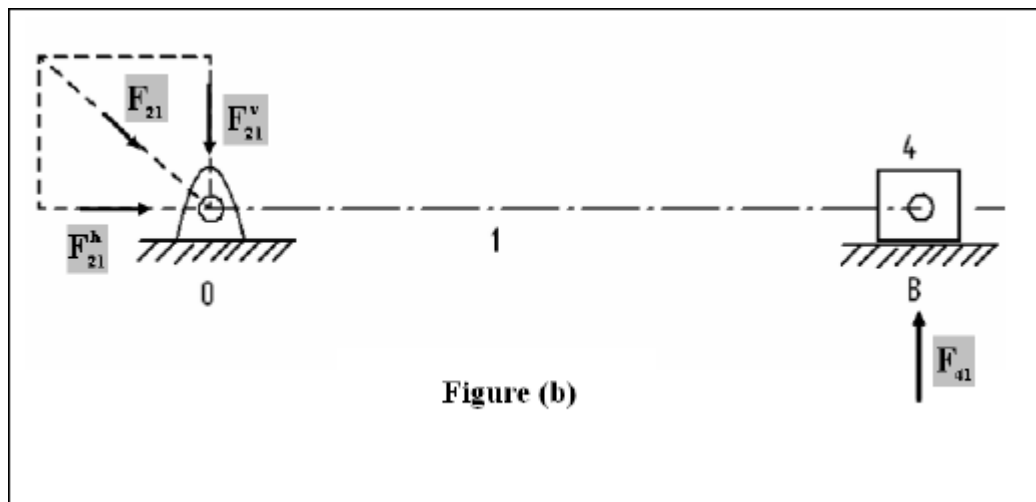
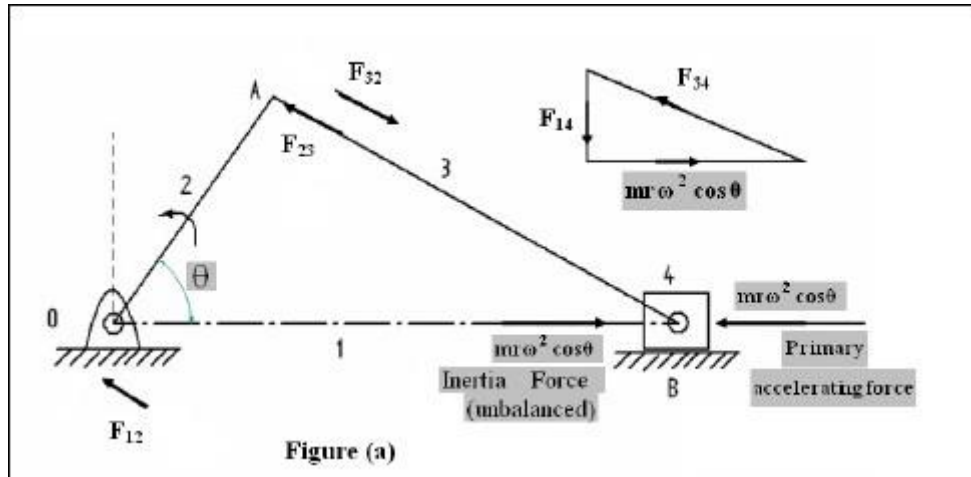

In Fig (b), the forces acting on the engine frame due to inertia force are shown.

At 'O' the force exerted by the crankshaft on the main bearings has two components, horizontal F_{21}^h and vertical F_{21}^v .

F_{21}^h is an horizontal force, which is an **unbalanced shaking force**.

F_{21}^v and F_{41} balance each other but form an **unbalanced shaking couple**.

The magnitude and direction of these unbalanced force and couple go on changing with angle θ . The shaking force produces linear vibrations of the frame in horizontal direction, whereas the shaking couple produces an oscillating vibration.

The shaking force F_{21}^h is the only unbalanced force which may hamper the smooth running of the engine and effort is made to balance the same.

However it is not at all possible to balance it completely and only some modifications can be carried out.

Balancing Of The Shaking Force:

Shaking force is being balanced by adding a rotating counter mass at radius 'r' directly opposite the crank. This provides only a partial balance. This counter mass is in addition to the mass used to balance the rotating unbalance due to the mass at the crank pin. This is shown in figure (c).

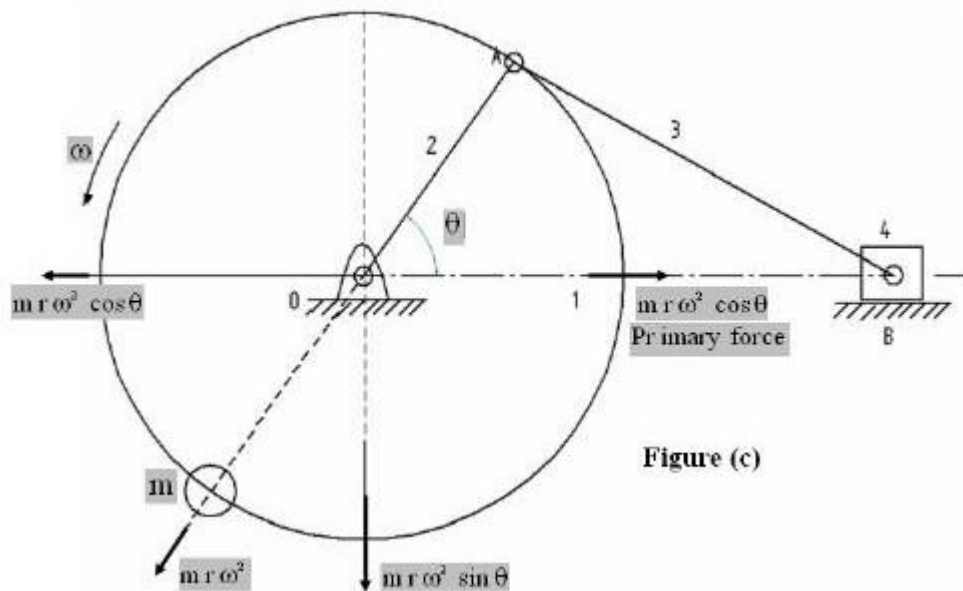

The horizontal component of the centrifugal force due to the balancing mass is $mr\omega^2 \cos\theta$ and this is in the line of stroke. This component neutralizes the unbalanced reciprocating force. But the rotating mass also has a component $mr\omega^2 \sin\theta$ perpendicular to the line of stroke which remains unbalanced. The unbalanced force is zero at $\theta = 0^\circ$ or 180° and maximum at the middle of the stroke i.e. $\theta = 90^\circ$. The magnitude or the maximum value of the unbalanced force remains the same i.e. equal to $mr\omega^2$. Thus instead of sliding to and fro on its mounting, the mechanism tends to jump up and down.

To minimize the effect of the unbalance force a compromise is, usually made, is $\frac{2}{3}$ of the reciprocating mass is balanced or a value between $\frac{1}{2}$ to $\frac{3}{4}$.

If 'c' is the fraction of the reciprocating mass, then

The primary force balanced by the mass = $c m r \omega^2 \cos \theta$

and

The primary force unbalanced by the mass = $(1 - c) m r \omega^2 \cos \theta$

Vertical component of centrifugal force which remains unbalanced = $c m r \omega^2 \sin \theta$

In reciprocating engines, unbalance forces in the direction of the line of stroke are more dangerous than the forces perpendicular to the line of stroke.

Resultant unbalanced force at any instant

$$= \sqrt{[(1 - c)m r \omega^2 \cos \theta]^2 + [c m r \omega^2 \sin \theta]^2}$$

The resultant unbalanced force is minimum when, $c = \frac{1}{2}$

This method is just equivalent to as if a revolving mass at the crankpin is completely balanced by providing a counter mass at the same radius diametrically opposite to the crank. Thus if m_p is the mass at the crankpin and 'c' is the fraction of the reciprocating mass 'm' to be balanced, the mass at the crankpin may be considered as $c m + m_p$ which is to be completely balanced.

SECONDARY BALANCING:

Secondary acceleration force is equal to $m r \omega^2 \frac{\cos 2\theta}{n}$ -----(1)

Its frequency is twice that of the primary force and the magnitude $\frac{1}{n}$ times the magnitude of the primary force.

The secondary force is also equal to $m r (2\omega)^2 \frac{\cos 2\theta}{4n}$ -----(2)

Consider, two cranks of an engine, one actual one and the other imaginary with the following specifications.

	Actual	Imaginary
Angular velocity	ω	2ω
Length of crank	r	$\frac{r}{4n}$
Mass at the crank pin	m	m

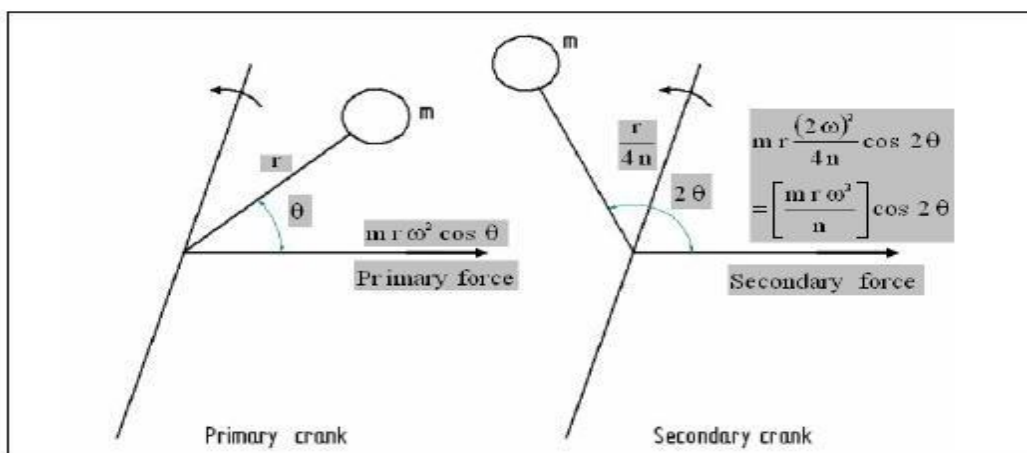

$$\text{Centrifugal force induced in the imaginary crank} = \frac{mr(2\omega)^2}{4n}$$

$$\text{Component of this force along the line of stroke is} = \frac{mr(2\omega)^2}{4n} \cos 2\theta$$

Thus the effect of the secondary force is equivalent to an imaginary crank of length $\frac{r}{4n}$ rotating at double the angular velocity, i.e. twice of the engine speed. The imaginary crank coincides with the actual at inner top-dead centre. At other times, it makes an angle with the line of stroke equal to twice that of the engine crank.

The secondary couple about a reference plane is given by the multiplication of the secondary force with the distance 'l' of the plane from the reference plane.

COMPLETE BALANCING OF RECIPROCATING PARTS

Conditions to be fulfilled:

1. Primary forces must balance i.e., primary force polygon is enclosed.
2. Primary couples must balance i.e., primary couple polygon is enclosed.
3. Secondary forces must balance i.e., secondary force polygon is enclosed.
4. Secondary couples must balance i.e., secondary couple polygon is enclosed.

Usually, it is not possible to satisfy all the above conditions fully for multi-cylinder engine. Mostly some unbalanced force or couple would exist in the reciprocating engines.

Module-6

Vibration of machine parts 6.1 Introduction to Vibration and related terms (Amplitude, time period and frequency, cycle) 6.2 Classification of vibration. 6.3 Basic concept of natural, forced & damped vibration 6.4 Torsional and Longitudinal vibration. 6.5 Causes & remedies of vibration

Introduction

When elastic bodies such as a spring, a beam and a shaft are displaced from the equilibrium position by the application of external forces, and then released, they execute a **vibratory motion**.

Classify vibrations**1-Free or natural vibrations**

- Longitudinal vibrations,
- Transverse vibrations
- Torsional vibrations.

2- Forced vibrations**3-Damped vibrations.****Natural Vibration**

When no external force acts on the body, after giving it an initial displacement, then the body is said to be under **free or natural vibrations**. The frequency of the free vibrations is called **free or natural frequency**.

- **Longitudinal vibrations.** When the particles of the shaft or disc moves parallel to the axis of the shaft, as shown in Fig (a), then the vibrations are known as **longitudinal vibrations**.

In this case, the shaft is elongated and shortened alternately and thus the tensile and compressive

stresses are induced alternately in the shaft. Purely longitudinal vibration occurs when all

particles of the body move in only one direction.

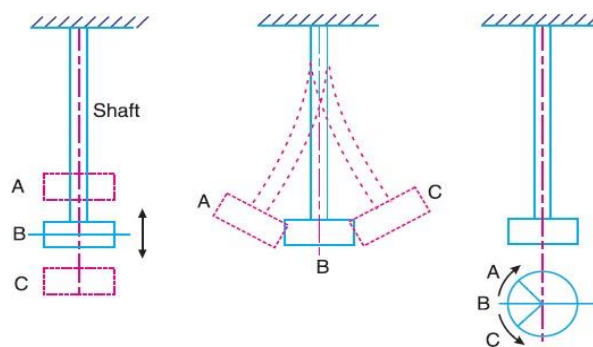

B = Mean position ; A and C = Extreme positions.

(a) Longitudinal vibrations. (b) Transverse vibrations. (c) Torsional vibrations.

- **2. Transverse vibrations.** When the particles of the shaft or disc move approximately perpendicular to the axis of the shaft, as shown in Fig. (b), then the

vibrations are known as **transverse vibrations**. In this case, the shaft is straight and bent alternately and bending stresses are induced in the shaft.

- **3. Torsional vibrations.** When the particles of the shaft or disc move in a circle about the axis of the shaft, as shown in Fig.(c), then the vibrations are known as **torsional vibrations**. In this case, the shaft is twisted and untwisted alternately and the torsional shear stresses are induced in the shaft.

2- Forced vibrations.

When the body vibrates under the influence of external force, then the body is said to be under **forced vibrations**. The external force applied to the body is a periodic disturbing force created by unbalance. The vibrations have the same frequency as the applied force.

3-Damped vibrations.

When there is a reduction in amplitude over every cycle of vibration, the motion is said to be **damped vibration**. This is due to the fact that a certain amount of energy possessed by the vibrating system is always dissipated in overcoming frictional resistances to the motion.

Define with respect to vibration

Cycle:

Amplitude:

Time Period:

1. Period of vibration or time period. It is the time interval after which the motion is repeated itself. The period of vibration is usually expressed in seconds.

2. Cycle. It is the motion completed during one time period.

3. Frequency. It is the number of cycles described in one second. In S.I. units, the frequency is expressed in hertz (briefly written as Hz) which is equal to one cycle per second.

State the causes of Vibration

Unbalance: This is basically in reference to the rotating bodies. The uneven distribution of mass in a rotating body contributes to the unbalance. A good example of unbalance related vibration would be the —vibrating alert in our mobile phones. Here a small amount of unbalanced weight is rotated by a motor causing the vibration which makes the mobile phone to vibrate. You would have experienced the same sort of vibration occurring in your front loaded washing machines that tend to vibrate during the —spinning mode.

Misalignment: This is an other major cause of vibration particularly in machines that are driven by motors or any other prime movers.

Bent Shaft: A rotating shaft that is bent also produces the the vibrating effect since it losses its rotation capability about its center.

Gears in the machine: The gears in the machine always tend to produce vibration, mainly due to their meshing. Though this may be controlled to some extent, any problem in the gearbox tends to get enhanced with ease.

Bearings: Last but not the least, here is a major contributor for vibration. In majority of the cases every initial problem starts in the bearings and propagates to the rest of the members of the machine. A bearing devoid of lubrication tends to wear out fast and fails

quickly, but before this is noticed it damages the remaining components in the machine and an initial look would seem as if something had gone wrong with the other components leading to the bearing failure.

Effects of vibration:

(a) Bad Effects: The presence of vibration in any mechanical system produces unwanted noise, high stresses, poor reliability, wear and premature failure of parts. Vibrations are a great source of human discomfort in the form of physical and mental strains.

(b) Good Effects: A vibration does useful work in musical instruments, vibrating screens, shakers, relieve pain in physiotherapy

Methods of reduction of vibration:

- -unbalance is its main cause, so balancing of parts is necessary.
- using shock absorbers.
- using dynamic vibration absorbers.
- providing the screens (if noise is to be reduced)

Module-2

Friction Clutches

A friction clutch has its principal application in the transmission of power of shafts and machines which must be started and stopped frequently. Its application is also found in cases in which power is to be delivered to machines partially or fully loaded. The force of friction is used to start the driven shaft from rest and gradually brings it up to the proper speed without excessive slipping of the friction surfaces. In automobiles, friction clutch is used to connect the engine to the driven shaft. In operating such a clutch, care should be taken so that the friction surfaces engage easily and gradually brings the driven shaft up to proper speed. The proper alignment of the bearing must be maintained and it should be located as close to the clutch as possible. It may be noted that

1. The contact surfaces should develop a frictional force that may pick up and hold the load with reasonably low pressure between the contact surfaces.
2. The heat of friction should be rapidly dissipated and tendency to grab should be at a minimum.
3. The surfaces should be backed by a material stiff enough to ensure a reasonably uniform distribution of pressure.

The friction clutches of the following types are important from the subject point of view :

1. Disc or plate clutches (single disc or multiple disc clutch),
2. Cone clutches, and
3. Centrifugal clutches.

Single Disc or Plate Clutch

A single disc or plate clutch, as shown in Fig. 10.21, consists of a clutch plate whose both sides are faced with a friction material (usually of Ferrodo). It is mounted on the hub which is free to move axially along the splines of the driven shaft. The pressure plate is mounted inside the clutch body which is bolted to the flywheel. Both the pressure plate and the flywheel rotate with the engine crankshaft or the driving shaft. The pressure plate pushes the clutch plate towards the flywheel by a set of strong springs which are arranged radially inside the body. The three levers (also known as release levers or fingers) are carried on pivots suspended from the case of the body. These are arranged in such a manner so that the pressure plate moves away from the flywheel by the inward movement of a thrust bearing. The bearing is mounted upon a forked shaft and moves forward when the clutch pedal is pressed.

When the clutch pedal is pressed down, its linkage forces the thrust release bearing to move in towards the flywheel and pressing the longer ends of the levers inward. The levers are forced to turn on their suspended pivot and the pressure plate moves away from the flywheel by the knife edges, thereby compressing the clutch springs. This action removes the pressure from the clutch plate and thus moves back from the flywheel and the driven shaft becomes stationary. On the other hand, when the foot is taken off from the clutch pedal, the thrust

bearing moves back by the levers. This allows the springs to extend and thus the pressure plate pushes the clutch plate back towards the flywheel.

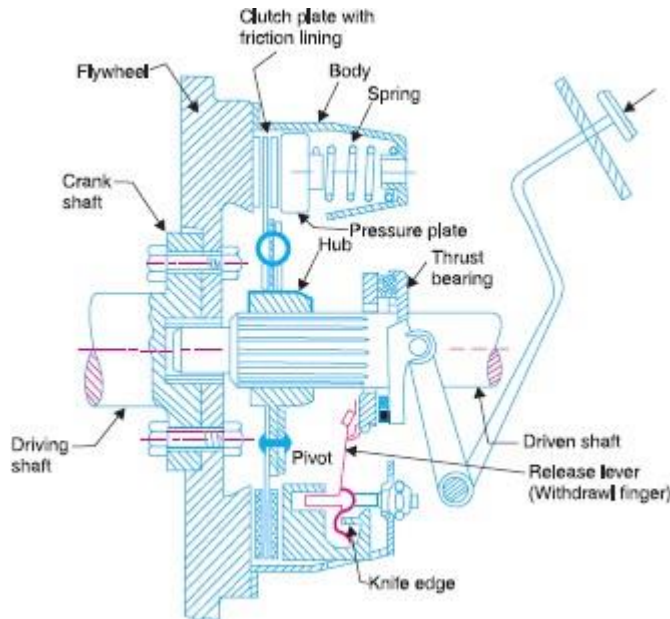

- Let T = Torque transmitted by the clutch,
 p = Intensity of axial pressure with which the contact surfaces are t together,
 r_1 and r_2 = External and internal radii of friction faces, and
 μ = Coefficient of friction.

Consider an elementary ring of radius r and thickness dr as shown in Fig. 10.22 (b).

We know that area of contact surface or friction surface,

$$= 2 \pi r . dr$$

\therefore Normal or axial force on the ring,

$$\delta W = \text{Pressure} \times \text{Area} = p \times 2 \pi r . dr$$

and the frictional force on the ring acting tangentially at radius r ,

$$F_r = \mu . \delta W = \mu . p \times 2 \pi r . dr$$

\therefore Frictional torque acting on the ring,

$$T_r = F_r \times r = \mu . p \times 2 \pi r . dr \times r = 2 \pi \times \mu . p . r^2 . dr$$

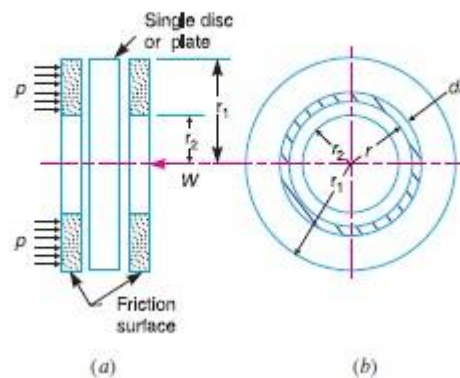

1. Considering uniform pressure

When the pressure is uniformly distributed over the entire area of the friction face, then the intensity of pressure,

$$p = \frac{W}{\pi[(r_1)^2 - (r_2)^2]} \quad \dots(i)$$

where $W =$ Axial thrust with which the contact or friction surfaces are held together.

We have discussed above that the frictional torque on the elementary ring of radius r and thickness dr is

$$T_r = 2 \pi \mu . p . r^2 . dr$$

Integrating this equation within the limits from r_2 to r_1 for the total frictional torque.

\therefore Total frictional torque acting on the friction surface or on the clutch,

$$T = \int_{r_2}^{r_1} 2 \pi \mu . p . r^2 . dr = 2 \pi \mu p \left[\frac{r^3}{3} \right]_{r_2}^{r_1} = 2 \pi \mu p \left[\frac{(r_1)^3 - (r_2)^3}{3} \right]$$

Substituting the value of p from equation (i),

$$\begin{aligned} T &= 2 \pi \mu \times \frac{W}{\pi[(r_1)^2 - (r_2)^2]} \times \frac{(r_1)^3 - (r_2)^3}{3} \\ &= \frac{2}{3} \times \mu . W \left[\frac{(r_1)^3 - (r_2)^3}{(r_1)^2 - (r_2)^2} \right] = \mu . W . R \end{aligned}$$

where $R =$ Mean radius of friction surface

$$= \frac{2}{3} \left[\frac{(r_1)^3 - (r_2)^3}{(r_1)^2 - (r_2)^2} \right]$$

2. Considering uniform wear

In Fig. 10.22, let p be the normal intensity of pressure at a distance r from the axis of the clutch. Since the intensity of pressure varies inversely with the distance, therefore

$$p . r = C \text{ (a constant) or } p = C/r \quad \dots(i)$$

and the normal force on the ring,

$$\delta W = p . 2 \pi r . dr = \frac{C}{r} \times 2 \pi C . dr = 2 \pi C . dr$$

\therefore Total force acting on the friction surface,

$$W = \int_{r_2}^{r_1} 2 \pi C . dr = 2 \pi C \left[r \right]_{r_2}^{r_1} = 2 \pi C (r_1 - r_2)$$

or

$$C = \frac{W}{2 \pi (r_1 - r_2)}$$

We know that the frictional torque acting on the ring,

$$T_r = 2 \pi \mu . p r^2 . dr = 2 \pi \mu \times \frac{C}{r} \times r^2 . dr = 2 \pi \mu . C . r . dr$$

\therefore Total frictional torque on the friction surface,

$$\begin{aligned} T &= \int_{r_2}^{r_1} 2 \pi \mu . C . r . dr = 2 \pi \mu . C \left[\frac{r^2}{2} \right]_{r_2}^{r_1} = 2 \pi \mu . C \left[\frac{(r_1)^2 - (r_2)^2}{2} \right] \\ &= \pi \mu . C [(r_1)^2 - (r_2)^2] = \pi \mu \times \frac{W}{2 \pi (r_1 - r_2)} [(r_1)^2 - (r_2)^2] \\ &= \frac{1}{2} \times \mu . W (r_1 + r_2) = \mu . W . R \end{aligned}$$

where

$$n = \text{Number of pairs of friction or contact surfaces, and}$$

$$R = \text{Mean radius of friction surface}$$

$$= \frac{2}{3} \left[\frac{(r_1)^3 - (r_2)^3}{(r_1)^2 - (r_2)^2} \right] \quad \dots(\text{For uniform pressure})$$

$$= \frac{r_1 + r_2}{2} \quad \dots(\text{For uniform wear})$$

2. For a single disc or plate clutch, normally both sides of the disc are effective. Therefore, a single disc clutch has two pairs of surfaces in contact, i.e. $n = 2$.

3. Since the intensity of pressure is maximum at the inner radius (r_2) of the friction or contact surface, therefore equation (i) may be written as

$$p_{max} \times r_2 = C \quad \text{or} \quad p_{max} = C/r_2$$

4. Since the intensity of pressure is minimum at the outer radius (r_1) of the friction or contact surface, therefore equation (i) may be written as

$$p_{min} \times r_1 = C \quad \text{or} \quad p_{min} = C/r_1$$

5. The average pressure (p_{av}) on the friction or contact surface is given by

$$p_{av} = \frac{\text{Total force on friction surface}}{\text{Cross-sectional area of friction surface}} = \frac{W}{\pi[(r_1)^2 - (r_2)^2]}$$

6. In case of a new clutch, the intensity of pressure is approximately uniform but in an old clutch the uniform wear theory is more approximate.

7. The uniform pressure theory gives a higher frictional torque than the uniform wear theory. Therefore in case of friction clutches, uniform wear should be considered, unless otherwise stated.

Reference

Theory Of Machine By R S Khurmi

Theory Of Machine By R K Bansal